

***EPOS***  
***Positioning Controllers***  
***Command Library***

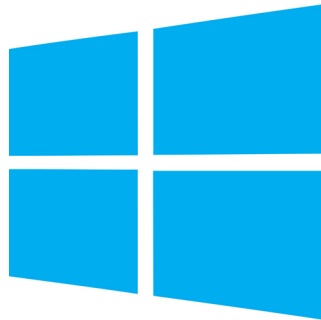

[epos.maxonmotor.com](http://epos.maxonmotor.com)

***Document ID: rel8488***

TABLE OF CONTENTS



**Function Group Overview**

For a detailed overview on function groups see page 12-167.

<b>1</b>	<b>About this Document</b>	<b>5</b>
<b>2</b>	<b>Introduction</b>	<b>9</b>
<b>3</b>	<b>Initialization Functions</b>	<b>13</b>
	3.1 Communication .....	13
	3.2 Info .....	22
	3.3 Advanced Functions.....	24
<b>4</b>	<b>Configuration Functions</b>	<b>33</b>
	4.1 General.....	33
	4.2 Advanced Functions.....	38
<b>5</b>	<b>Operation Functions</b>	<b>59</b>
	5.1 Operation Mode .....	59
	5.2 State Machine .....	61
	5.3 Error Handling .....	66
	5.4 Motion Info .....	68
	5.5 Profile Position Mode (PPM) .....	72
	5.6 Profile Velocity Mode (PVM) .....	76
	5.7 Homing Mode (HM) .....	80
	5.8 Interpolated Position Mode (IPM).....	85
	5.9 Position Mode (PM) .....	90
	5.10 Velocity Mode (VM) .....	94
	5.11 Current Mode (CM) .....	98
	5.12 Master Encoder Mode (MEM) .....	102

**READ THIS FIRST**

**These instructions are intended for qualified technical personnel. Prior commencing with any activities...**

- you must carefully read and understand this manual and
- you must follow the instructions given therein.

**EPOS positioning controllers are considered as partly completed machinery according to EU Directive 2006/42/EC, Article 2, Clause (g) and are intended to be incorporated into or assembled with other machinery or other partly completed machinery or equipment.**

**Therefore, you must not put the device into service,...**

- unless you have made completely sure that the other machinery fully complies with the EU directive's requirements!
- unless the other machinery fulfills all relevant health and safety aspects!
- unless all respective interfaces have been established and fulfill the herein stated requirements!

5.13	Step Direction Mode (SDM) . . . . .	104
5.14	Inputs & Outputs . . . . .	106
<b>6</b>	<b>Data Recording Functions</b>	<b>123</b>
6.1	Operation Mode . . . . .	123
6.2	Data Recorder Status . . . . .	126
6.3	Data Recorder Data . . . . .	129
6.4	Advanced Functions . . . . .	131
<b>7</b>	<b>Low Layer Functions</b>	<b>133</b>
7.1	CAN Layer . . . . .	133
<b>8</b>	<b>Error Overview</b>	<b>135</b>
8.1	Communication Errors . . . . .	135
8.2	Library Errors . . . . .	136
<b>9</b>	<b>Supported Operating Systems</b>	<b>139</b>
9.1	Windows . . . . .	140
9.1.1	Overview . . . . .	140
9.1.2	Integration into Programming Environment . . . . .	141
9.1.3	Programming . . . . .	149
9.2	Linux . . . . .	152
9.2.1	Overview . . . . .	152
9.2.2	Installation / Uninstallation . . . . .	154
9.2.3	Integration into Programming Environment . . . . .	155
9.2.4	Programming . . . . .	155
<b>10</b>	<b>Version History</b>	<b>157</b>
	<b>Appendix A — Hardware vs. Functions</b>	<b>161</b>
	<b>Appendix B — Function Groups Overview</b>	<b>167</b>

---

*••page intentionally left blank••*

# 1 About this Document



## **We strongly stress the following facts:**

- *The present document does not replace any other documentation covering the basic installation and/or parameterization described therein!*
- *Also, any aspect in regard to health and safety as well as to secure and safe operation are not covered in the present document – it is intended and must be understood as complimenting addition to those documents!*

## 1.1 Intended Purpose

The present document provides instructions on the implemented functions of the...

- Windows Dynamic-Link Libraries «EposCmd.dll» and «EposCmd64.dll», as well as the
- Linux Shared Object Library «libEposCmd.so»

...which can be used for EPOS, EPOS2, and EPOS4 devices.

In addition, the document explains on how to integrate the DLLs into a variety of common programming environments.

## 1.2 Target Audience

This document is meant for trained and skilled personnel working with the equipment described. It conveys information on how to understand and fulfill the respective work and duties.

This document is a reference book. It does require particular knowledge and expertise specific to the equipment described.

## 1.3 How to use

Take note of the following notations and codes which will be used throughout the document.

Notation	Explanation
EPOS2	stands for "EPOS2 Positioning Controller"
EPOS4	stands for "EPOS4 Positioning Controller"
«Abcd»	indicating a title or a name (such as of document, product, mode, etc.)
▣Abcd▣	indicating an action to be performed using a software control element (such as folder, menu, drop-down menu, button, check box, etc.) or a hardware element (such as switch, DIP switch, etc.)
(n)	referring to an item (such as order number, list item, etc.)
➔	denotes "see", "see also", "take note of" or "go to"

Table 1-1 Notations used in this document

## 1.4 Symbols and Signs



### **Requirement / Note / Remark**

Indicates an action you must perform prior continuing or refers to information on a particular item.



### **Best Practice**

Gives advice on the easiest and best way to proceed.



### **Material Damage**

Points out information particular to potential damage of equipment.

## 1.5 Sources for additional Information

For further details and additional information, please refer to below listed sources:

Topic	Reference
Eclipse	<a href="http://eclipse.org/">http://eclipse.org/</a>
FTDI Driver	<a href="http://www.ftdichip.com">www.ftdichip.com</a>
Functions	Not all functions are supported by all devices as they are dependent on the device version and the firmware version. For details → separate documents «Firmware Specification» and «Hardware Reference» of the respective positioning controller.
Index / Subindex	For detailed descriptions on used objects → separate document «Firmware Specification».
IXXAT	<a href="http://www.ixxat.de">www.ixxat.de</a>
Kvaser	<a href="http://www.kvaser.com">www.kvaser.com</a>
maxon motor	<a href="http://www.maxonmotor.com">www.maxonmotor.com</a>
Microsoft Developer Network (MSDN)	<a href="http://msdn.microsoft.com/">http://msdn.microsoft.com/</a>
National Instruments (NI)	<a href="http://www.ni.com/can">www.ni.com/can</a>
Objects	Not all objects are supported by all devices as they are dependent on the device version and the firmware version. For details → separate documents «Firmware Specification» and «Hardware Reference» of the respective positioning controller.
Vector	<a href="http://www.vector-informatik.com">www.vector-informatik.com</a>

Table 1-2 Sources for additional information

## 1.6 Trademarks and Brand Names

For easier legibility, registered brand names are listed below and will not be further tagged with their respective trademark. It must be understood that the brands (the below list is not necessarily concluding) are protected by copyright and/or other intellectual property rights even if their legal trademarks are omitted in the later course of this document.

Brand name	Trademark owner
Adobe® Reader®	© Adobe Systems Incorporated, USA-San Jose, CA
Borland C++ Builder™ Borland®	© Borland Software Corporation, USA-Rockville MD
CANopen® CiA®	© CiA CAN in Automation e.V, DE-Nuremberg
Eclipse™	© Eclipse Foundation, Inc., CDN-Ottawa ON
Jetson™ NVIDIA®	© NVIDIA Corporation, USA-Santa Clara CA
LabVIEW™ LabWindows™	© National Instruments Corporation, USA-Austin TX
Linux®	© Linus Torvalds (The Linux Foundation, USA-San Francisco CA)
NI-CAN™ NI-XNET™	© National Instruments Corporation, USA-Austin TX
Ubuntu	© Canonical Group Limited, UK-London
Visual Basic® Visual C#® Visual C++®	© Microsoft Corporation, USA-Redmond WA
Windows®	© Microsoft Corporation, USA-Redmond WA

Table 1-3 Brand Names and trademark owners

## 1.7 Legal Notice

The present document is based on maxon motor's experience. maxon motor explicitly states that its content is true and correct as to maxon motor's best knowledge.

Note that all legal aspects, such as terms of use, property rights, warranty, applicable law, and others are covered and valid as stated in the maxon motor's «EPOS Studio» End User License Agreement (EULA) which you have agreed to upon initial installation and prior employment of the «EPOS Studio».

## 1.8 Copyright

© 2018 maxon motor. All rights reserved.

The present document – including all parts thereof – is protected by copyright. Any use (including reproduction, translation, microfilming, and other means of electronic data processing) beyond the narrow restrictions of the copyright law without the prior approval of maxon motor ag, is not permitted and subject to prosecution under the applicable law.

**maxon motor ag**  
Brünigstrasse 220  
P.O.Box 263  
CH-6072 Sachseln

Phone +41 41 666 15 00  
Fax +41 41 666 16 50  
Web [www.maxonmotor.com](http://www.maxonmotor.com)

*••page intentionally left blank••*



## 2 Introduction

### 2.1 Documentation Structure

The present document is part of a documentation set. Find below an overview on the documentation hierarchy and the interrelationship of its individual parts:

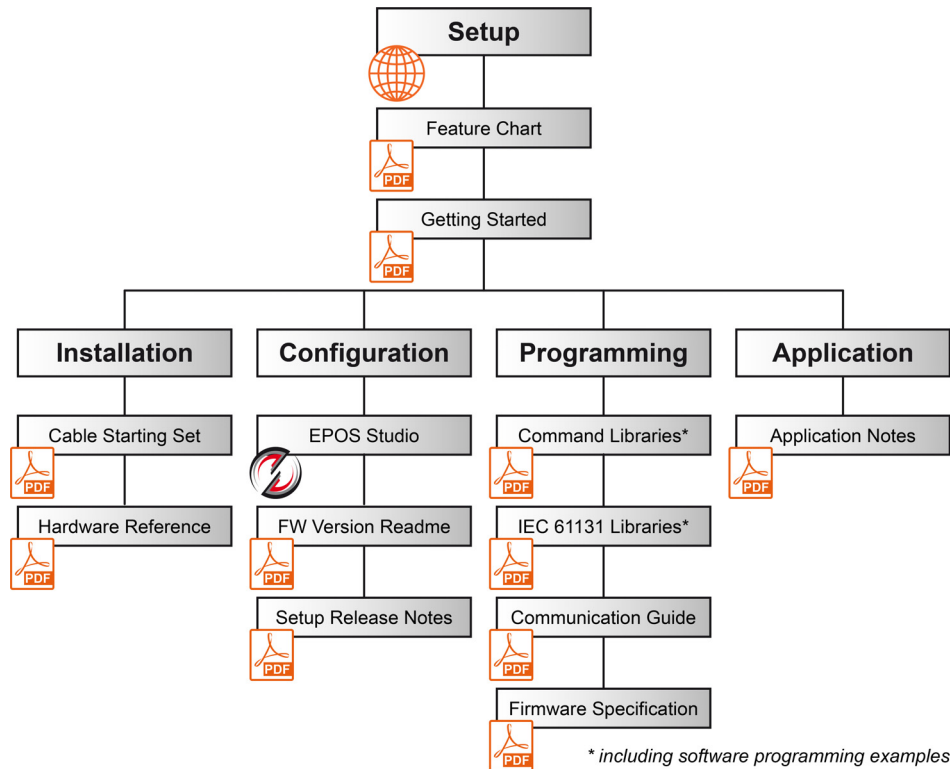

Figure 2-1 EPOS2 documentation structure

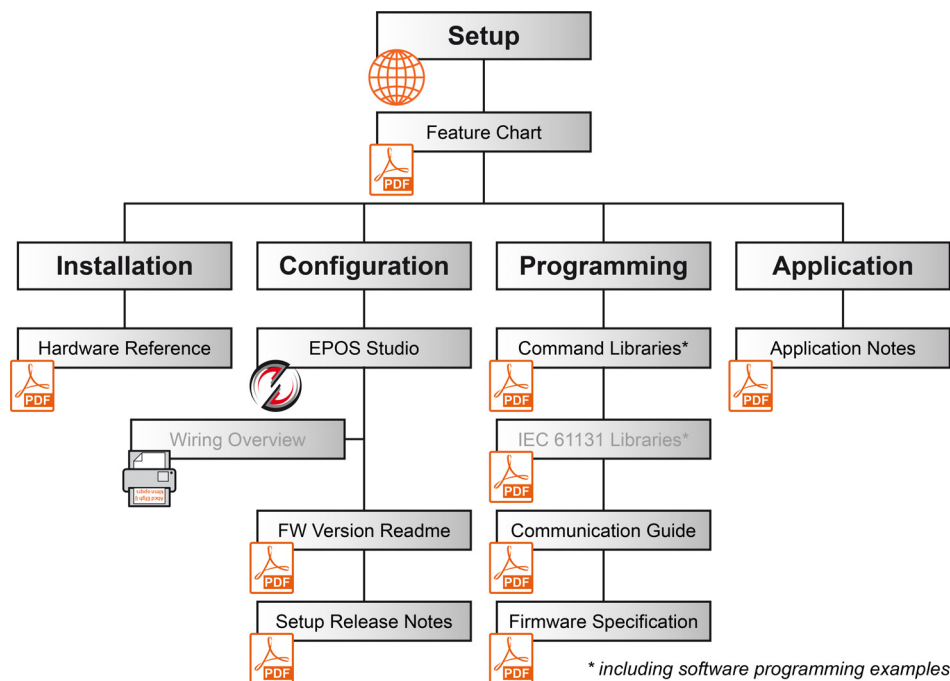

Figure 2-2 EPOS4 documentation structure

## 2.2 General Information

The «EPOS Command Libraries» are arranged in groups of functions and are intended to assist you in programming the control software based on Microsoft Windows 32-bit and 64-bit as well as Linux operating systems.

The document describes the interfaces between the control software and the libraries. They support maxon motor's EPOS devices, which are connected to a serial RS232, USB, or CAN interface.

The parameters for 32-bit and 64-bit interfaces are identical. The libraries support the CANopen SDO protocol but are not suitable for real-time communication.

Refer to these chapters for in detail information on library functions and integration into your programming environment:

3 Initialization Functions . . . . .	3-13
4 Configuration Functions . . . . .	4-33
5 Operation Functions . . . . .	5-59
6 Data Recording Functions . . . . .	6-123
7 Low Layer Functions . . . . .	7-133
9 Supported Operating Systems . . . . .	9-139

Find the latest edition of the present document, as well as additional documentation and software to the EPOS Positioning Controllers also on the Internet: →[www.maxonmotor.com](http://www.maxonmotor.com)

## 2.3 Products by Third Party Suppliers

For manufacturers' contact information → "Sources for additional Information" on page 1-6.

Supplier	Products
<b>IXXAT</b>	IXXAT CANopen interfaces can be operated with the hardware-independent "VCI driver V3" or "VCI driver V4" (Virtual CAN Interface). Check in advanced whether the interface is supported by VCI 3 or VCI 4.
<b>Kvaser</b>	Kvaser CAN interfaces are supported. Thereby, respective driver software and hardware must be installed.
<b>National Instruments</b>	National Instruments CAN interfaces are supported. Thereby, «NI-XNET» or «NI-CAN» software and hardware must be installed.
<b>Vector</b>	For Vector CANopen cards, the "XL-Driver-Library" will be required. The library must be manually installed in the appropriate working directory (or system directory). With this library, you may write your own CANopen applications based on Vector's CAN hardware.

Table 2-4 Third party supplier products

## 2.4 Communication Structure

### 2.4.1 Windows / Linux

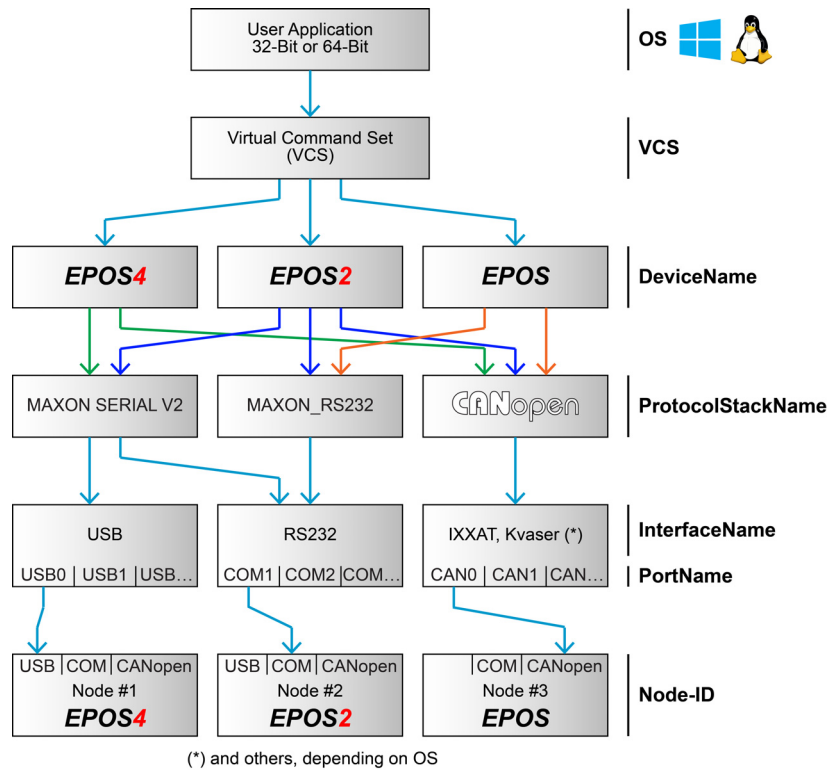

Figure 2-3 Windows / Linux – Communication structure (example)

### 2.4.2 Gateway

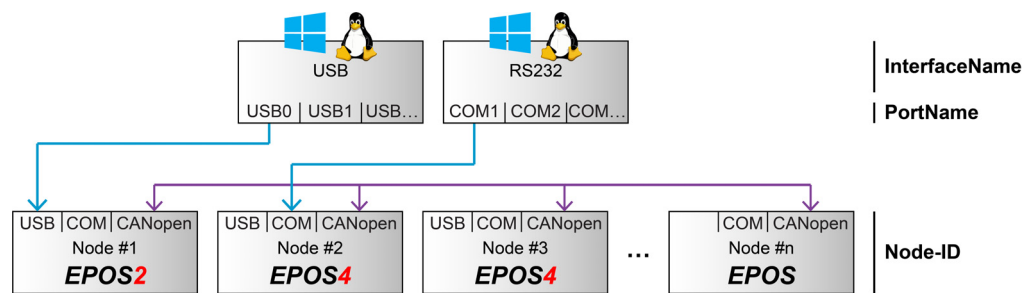

Figure 2-4 Gateway – Communication structure (example)

## 2.5 Data Type Definitions

Name	Data type	Size Bits	Size Bytes	Range	Comment
char, __int8	signed integer	8	1	-128...127	
BYTE	unsigned integer	8	1	0...255	
short	signed integer	16	2	-32'768...32'767	
WORD	unsigned integer	16	2	0...65'535	
long	signed integer	32	4	-2'147'483'648...2'147'483'647	
DWORD	unsigned integer	32	4	0...4'294'967'295	
BOOL	signed integer	32	4	TRUE = 1 FALSE = 0	
HANDLE	pointer to an object	32	4	0...4'294'967'295	Depending on OS
		64	8	0...18'446'744'073'709'551'615	

Table 2-5 Data type definitions

### 3 Initialization Functions



**Availability of functions**

The availability of certain functions depends on the used hardware. For an overview →“Appendix A — Hardware vs. Functions” on page 11-161.

#### 3.1 Communication

##### 3.1.1 VCS\_OpenDevice

**FUNCTION**

HANDLE VCS\_OpenDevice(char\* DeviceName, char\* ProtocolStackName, char\* InterfaceName, char\* PortName, DWORD\* pErrorCode)

**DESCRIPTION**

VCS\_OpenDevice opens the port to send and receive commands. Ports can be RS232, USB, and CANopen interfaces.

For correct designations on DeviceName, ProtocolStackName, InterfaceName, and PortName, use the functions →VCS\_GetDeviceNameSelection, →VCS\_GetProtocolStackNameSelection, →VCS\_GetInterfaceNameSelection, and →VCS\_GetPortNameSelection.

For gateway topologies use function →VCS\_OpenSubDevice.

**PARAMETERS**

DeviceName	char*	Name of connected device: <ul style="list-style-type: none"> <li>• EPOS</li> <li>• EPOS2</li> <li>• EPOS4</li> </ul>
ProtocolStackName	char*	Name of used communication protocol: <ul style="list-style-type: none"> <li>• MAXON_RS232</li> <li>• MAXON_SERIAL V2</li> <li>• CANopen</li> </ul>
InterfaceName	char*	Name of interface: <ul style="list-style-type: none"> <li>• RS232</li> <li>• USB</li> <li>• IXXAT_&lt;&lt;BoardName&gt;&gt; &lt;&lt;DeviceNumber&gt;&gt;</li> <li>• Kvaser_&lt;&lt;BoardName&gt;&gt; &lt;&lt;DeviceNumber&gt;&gt;</li> <li>• NI_&lt;&lt;BoardName&gt;&gt; &lt;&lt;DeviceNumber&gt;&gt;</li> <li>• Vector_&lt;&lt;BoardName&gt;&gt; &lt;&lt;DeviceNumber&gt;&gt;</li> </ul> <p><i>Remark:</i> Use “VCS_OpenDeviceDlg” or “VCS_GetInterfaceNameSel” to identify the exact name</p>
PortName	char*	Name of port: <ul style="list-style-type: none"> <li>• COM1, COM2, ...</li> <li>• USB0, USB1, ...</li> <li>• CAN0, CAN1, ...</li> </ul>

**RETURN PARAMETERS**

pErrorCode	DWORD*	Error information on the executed function
------------	--------	--

<b>Return Value</b>	HANDLE	Handle for communication port access. Nonzero if successful; otherwise “0”.
---------------------	--------	---

Continued on next page.

**PROGRAMMING EXAMPLE**

```

HANDLE keyHandle = 0;
char* deviceName = "EPOS2";
char* protocolStackName = "MAXON SERIAL V2";
char* interfaceName = "RS232";
char* portName = "COM1";
DWORD errorCode = 0;

keyHandle = VCS_OpenDevice(deviceName, protocolStackName, interfaceName, portName, &errorCode)
if (keyHandle > 0)
{
    //.....
    VCS_CloseDevice(keyHandle);
}
    
```

Figure 3-5 VCS\_OpenDevice (programming example)

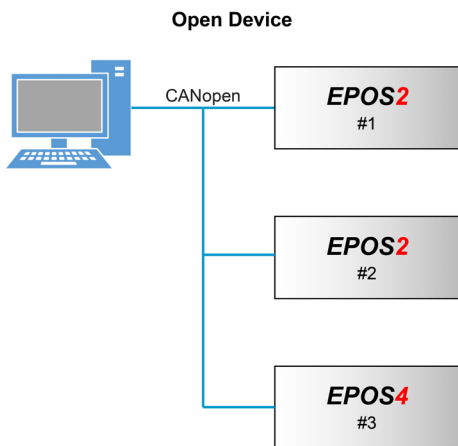

Figure 3-6 VCS\_OpenDevice (example)

For gateway topologies use OpenSubDevice (→chapter “3.1.8 VCS\_OpenSubDevice” on page 3-18).

**3.1.2 VCS\_OpenDeviceDlg**

**FUNCTION**

HANDLE VCS\_OpenDeviceDlg(DWORD\* pErrorCode)

**DESCRIPTION**

VCS\_OpenDeviceDlg recognizes available interfaces capable to operate with EPOS and opens the selected interface for communication. Not available with Linux.

**RETURN PARAMETERS**

pErrorCode	DWORD*	Error information on the executed function
------------	--------	--

<b>Return Value</b>	HANDLE	Handle for communication port access. Nonzero if successful; otherwise “0”.
---------------------	--------	---

### 3.1.3 VCS\_SetProtocolStackSettings

**FUNCTION**

BOOL VCS\_SetProtocolStackSettings(HANDLE KeyHandle, DWORD Baudrate, DWORD Timeout, DWORD\* pErrorCode)

**DESCRIPTION**

VCS\_SetProtocolStackSettings writes the communication parameters. For exact values on available baud rates, use function → VCS\_GetBaudRateSelection.

For correct communication, use the same baud rate as the connected device.

**PARAMETERS**

KeyHandle	HANDLE	Handle for port access
Baudrate	DWORD	Actual baud rate from opened port [bit/s]
Timeout	DWORD	Actual timeout from opened port [ms]

**RETURN PARAMETERS**

pErrorCode	DWORD*	Error information on the executed function
------------	--------	--

<b>Return Value</b>	BOOL	Nonzero if successful; otherwise "0"
---------------------	------	--------------------------------------

**PROGRAMMING EXAMPLE**

```

HANDLE keyHandle = 0;
char* deviceName = "EPOS2";
char* protocolStackName = "MAXON SERIAL V2";
char* interfaceName = "RS232";
char* portName = "COM1";
DWORD errorCode = 0;

keyHandle = VCS_OpenDevice(deviceName, protocolStackName, interfaceName, portName, &errorCode)
if (keyHandle > 0)
{
    if(VCS_SetProtocolStackSettings(keyHandle, 19200, 500, &errorCode) > 0)
    {
        //.....
    }

    VCS_CloseDevice(keyHandle);
}
    
```

Figure 3-7 VCS\_SetProtocolStackSettings (programming example)

### 3.1.4 VCS\_GetProtocolStackSettings

**FUNCTION**

BOOL VCS\_GetProtocolStackSettings(HANDLE KeyHandle, DWORD\* pBaudrate, DWORD\* pTimeout, DWORD\* pErrorCode)

**DESCRIPTION**

VCS\_GetProtocolStackSettings returns the baud rate and timeout communication parameters.

**PARAMETERS**

KeyHandle	HANDLE	Handle for port access
-----------	--------	------------------------

**RETURN PARAMETERS**

pBaudrate	DWORD*	Actual baud rate from opened port [bit/s]
pTimeout	DWORD*	Actual timeout from opened port [ms]
pErrorCode	DWORD*	Error information on the executed function

<b>Return Value</b>	BOOL	Nonzero if successful; otherwise "0"
---------------------	------	--------------------------------------

### 3.1.5 VCS\_FindDeviceCommunicationSettings

**FUNCTION**

BOOL VCS\_FindDeviceCommunicationSettings(HANDLE\* pKeyHandle, char\* pDeviceName, char\* pProtocolStackName, char\* pInterfaceName, char\* pPortName, WORD SizeName, DWORD\* pBaudrate, DWORD\* pTimeout, WORD\* pNodeId, int DialogMode, DWORD\* pErrorCode)

**DESCRIPTION**

VCS\_FindDeviceCommunicationSettings searches the communication setting parameters. Parameters can be defined to accelerate the process. The search will be terminated as the first device is found. Not available with Linux.

**PARAMETERS**

pKeyHandle	HANDLE*	Handle for port access
pDeviceName	char*	Device name
pProtocolStackName	char*	Protocol stack name
pInterfaceName	char*	Interface name
pPortName	char*	Port name
SizeName	WORD	Reserved memory size for return parameters
DialogMode	int	0: Show progress dialog 1: Show progress and confirmation dialog 2: Show confirmation dialog 3: Do not show any dialog

**RETURN PARAMETERS**

pKeyHandle	HANDLE*	Handle for port access
pDeviceName	char*	Device name
pProtocolStackName	char*	Protocol stack name
pInterfaceName	char*	Interface name
pPortName	char*	Port name
pBaudrate	DWORD*	Baud rate [bit/s]
pTimeout	DWORD*	Timeout [ms]
pNodeId	WORD*	Node-ID
pErrorCode	DWORD*	Error information on the executed function

<b>Return Value</b>	BOOL	Nonzero if successful; otherwise "0"
---------------------	------	--------------------------------------

### 3.1.6 VCS\_CloseAllDevices

**FUNCTION**

BOOL VCS\_CloseAllDevices(DWORD\* pErrorCode)

**DESCRIPTION**

VCS\_CloseAllDevices closes all opened ports for devices and subdevices and releases them for other applications. If no opened ports are available, the function returns "0".

**RETURN PARAMETERS**

pErrorCode	DWORD*	Error information on the executed function
------------	--------	--

<b>Return Value</b>	BOOL	Nonzero if successful; otherwise "0"
---------------------	------	--------------------------------------



### 3.1.7 VCS\_CloseDevice

#### FUNCTION

BOOL VCS\_CloseDevice(HANDLE KeyHandle, DWORD\* pErrorCode)

#### DESCRIPTION

VCS\_CloseDevice closes the port and releases it for other applications. If no opened ports are available, the function returns "0".

#### PARAMETERS

KeyHandle	HANDLE	Handle for port access
-----------	--------	------------------------

#### RETURN PARAMETERS

pErrorCode	DWORD*	Error information on the executed function
------------	--------	--

<b>Return Value</b>	BOOL	Nonzero if successful; otherwise "0"
---------------------	------	--------------------------------------

### 3.1.8 VCS\_OpenSubDevice

**FUNCTION**

HANDLE VCS\_OpenSubDevice(HANDLE DeviceHandle, char\* DeviceName, char\* ProtocolStackName, DWORD\* pErrorCode)

**DESCRIPTION**

VCS\_OpenSubDevice opens the subdevice connected to the gateway device to send and receive commands.

**PARAMETERS**

DeviceHandle	HANDLE	Handle from opened device
DeviceName	char*	Name of connected subdevice: • EPOS • EPOS2 • EPOS4
ProtocolStackName	char*	Name of used communication protocol: • CANopen

**RETURN PARAMETERS**

pErrorCode	DWORD*	Error information on the executed function
------------	--------	--

<b>Return Value</b>	HANDLE	Handle for gateway port access. Nonzero if successful; otherwise "0".
---------------------	--------	--

**PROGRAMMING EXAMPLE**

```

// device (gateway)
HANDLE keyHandle = 0;
char* deviceName = "EPOS2";
char* protocolStackName = "MAXON SERIAL V2";
char* interfaceName = "RS232";
char* portName = "COM1";
DWORD errorCode = 0;

// subdevice
HANDLE subkeyHandle = 0;
char* subdeviceName = "EPOS4"
char* subProtocolStackName = "CANopen";

keyHandle = VCS_OpenDevice(deviceName, protocolStackName, interfaceName, portName, &errorCode)
if(keyHandle > 0)
{
    subkeyHandle = VCS_OpenSubDevice(keyHandle, subdeviceName, subProtocolStackName, errorCode)
    if(subkeyHandle > 0)
    {
        //.....
        VCS_CloseSubDevice(subkeyHandle, errorCode)
    }

    VCS_CloseDevice(keyHandle, errorCode);
}
    
```

Figure 3-8 VCS\_OpenSubDevice (programming example)

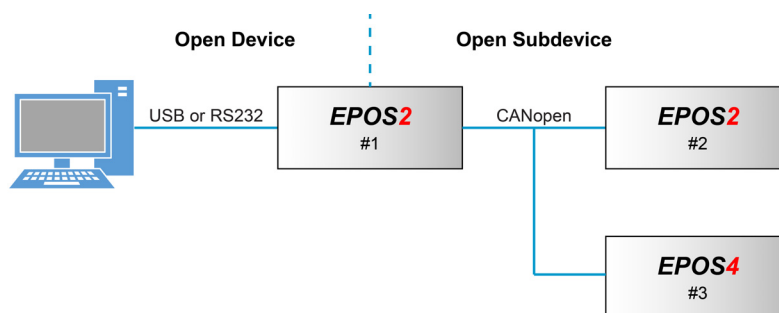

Figure 3-9 VCS\_OpenSubDevice (example)

**3.1.9 VCS\_OpenSubDeviceDlg****FUNCTION**

HANDLE VCS\_OpenSubDeviceDlg(HANDLE DeviceHandle, DWORD\* pErrorCode)

**DESCRIPTION**

VCS\_OpenSubDeviceDlg recognizes available subdevices capable to operate with the gateway device and opens the selected device for communication. Not available with Linux.

**PARAMETERS**

DeviceHandle	HANDLE	Handle from opened device
--------------	--------	---------------------------

**RETURN PARAMETERS**

pErrorCode	DWORD*	Error information on the executed function
------------	--------	--

<b>Return Value</b>	HANDLE	Handle for gateway port access. Nonzero if successful; otherwise "0".
---------------------	--------	--

**3.1.10 VCS\_SetGatewaySettings****FUNCTION**

BOOL VCS\_SetGatewaySettings(HANDLE KeyHandle, DWORD Baudrate, WORD\* pErrorCode)

**DESCRIPTION**

VCS\_SetGatewaySettings writes the gateway communication parameters to the device, stores them, and resets the gateway device. Not available with Linux.

The function does not set the communication parameters to all devices on the bus.

For correct communication, use the same baud rate as the connected devices.

**PARAMETERS**

KeyHandle	HANDLE	Handle for port access
Baudrate	DWORD	Actual baud rate from opened port [bit/s]

**RETURN PARAMETERS**

pErrorCode	DWORD*	Error information on the executed function
------------	--------	--

<b>Return Value</b>	BOOL	Nonzero if successful; otherwise "0".
---------------------	------	---------------------------------------

### 3.1.11 VCS\_GetGatewaySettings

**FUNCTION**

BOOL VCS\_GetGatewaySettings(HANDLE KeyHandle, DWORD\* pBaudrate, DWORD\* pErrorCode)

**DESCRIPTION**

VCS\_GetGatewaySettings returns the baud rate gateway communication parameter.

**PARAMETERS**

KeyHandle	HANDLE	Handle for port access
-----------	--------	------------------------

**RETURN PARAMETERS**

pBaudrate	DWORD*	Actual baud rate from opened port [bit/s]
pErrorCode	DWORD*	Error information on the executed function

<b>Return Value</b>	BOOL	Nonzero if successful; otherwise "0".
---------------------	------	---------------------------------------

### 3.1.12 VCS\_FindSubDeviceCommunicationSettings

**FUNCTION**

BOOL VCS\_FindSubDeviceCommunicationSettings(HANDLE DeviceHandle, HANDLE\* pKeyHandle, char\* pDeviceName, char\* pProtocolStackName, WORD SizeName, DWORD\* pBaudrate, WORD\* pNodeId, int DialogMode, DWORD\* pErrorCode)

**DESCRIPTION**

VCS\_FindSubDeviceCommunicationSettings searches the subdevice communication setting parameters. The parameters can be defined to accelerate the process. The search will be terminated as the first device is found. Not available with Linux.

**PARAMETERS**

DeviceHandle	HANDLE	Handle from opened device
SizeName	WORD	Reserved memory size for return parameters
DialogMode	int	0: Show progress dialog 1: Show progress and confirmation dialog 2: Show confirmation dialog 3: Do not show any dialog

**RETURN PARAMETERS**

pKeyHandle	HANDLE*	Handle for port access
pDeviceName	char*	Device name
pProtocolStackName	char*	ProtocolStack name
pBaudrate	DWORD*	Baud rate [bit/s]
pNodeId	WORD*	Node-ID
pErrorCode	DWORD*	Error information on the executed function

<b>Return Value</b>	BOOL	Nonzero if successful; otherwise "0".
---------------------	------	---------------------------------------

**3.1.13 VCS\_CloseAllSubDevices****FUNCTION**

BOOL VCS\_CloseAllSubDevices(HANDLE DeviceHandle, DWORD\* pErrorCode)

**DESCRIPTION**

VCS\_CloseAllSubDevices closes all opened subdevices and releases them for other applications.

**PARAMETERS**

DeviceHandle	HANDLE	Handle from opened device
--------------	--------	---------------------------

**RETURN PARAMETERS**

pErrorCode	DWORD*	Error information on the executed function
------------	--------	--

<b>Return Value</b>	BOOL	Nonzero if successful; otherwise "0".
---------------------	------	---------------------------------------

**3.1.14 VCS\_CloseSubDevice****FUNCTION**

BOOL VCS\_CloseSubDevice(HANDLE KeyHandle, DWORD\* pErrorCode)

**DESCRIPTION**

VCS\_CloseSubDevice closes the subdevice and releases it for other applications.

**PARAMETERS**

KeyHandle	HANDLE	Handle for port access
-----------	--------	------------------------

**RETURN PARAMETERS**

pErrorCode	DWORD*	Error information on the executed function
------------	--------	--

<b>Return Value</b>	BOOL	Nonzero if successful; otherwise "0".
---------------------	------	---------------------------------------

## 3.2 Info

### 3.2.1 VCS\_GetErrorInfo

**FUNCTION**

BOOL VCS\_GetErrorInfo(DWORD ErrorCodeValue, char\* pErrorInfo, WORD MaxStrSize)

**DESCRIPTION**

VCS\_GetErrorInfo returns the error information on the executed function from a received error code. It returns communication and library errors (but not device error descriptions). For error codes → chapter “8 Error Overview” on page 8-135.

**PARAMETERS**

ErrorCodeValue	DWORD	Received error code
MaxStrSize	WORD	Max. length of error string

**RETURN PARAMETERS**

pErrorCode	char*	Error string
------------	-------	--------------

<b>Return Value</b>	BOOL	Nonzero if successful; otherwise “0”
---------------------	------	--------------------------------------

### 3.2.2 VCS\_GetDriverInfo

**FUNCTION**

BOOL VCS\_GetDriverInfo(char\* pLibraryName, WORD MaxStrNameSize, char\* pLibraryVersion, WORD MaxStrVersionSize, DWORD\* pErrorCode)

**DESCRIPTION**

VCS\_GetDriverInfo returns the name and version from the «EPOS Command Library».

**PARAMETERS**

MaxStrNameSize	WORD	Reserved memory size for the name
MaxStrVersionSize	WORD	Reserved memory size for the version

**RETURN PARAMETERS**

pLibraryName	char*	Name from the library
pLibraryVersion	char*	Version from the library
pErrorCode	DWORD*	Error information on the executed function

<b>Return Value</b>	BOOL	Nonzero if successful; otherwise “0”
---------------------	------	--------------------------------------

**3.2.3 VCS\_GetVersion****FUNCTION**

BOOL VCS\_GetVersion(HANDLE KeyHandle, WORD NodeId, WORD\* pHardwareVersion, WORD\* pSoftwareVersion, WORD\* pApplicationNumber, WORD\* pApplicationVersion, DWORD\* pErrorCode)

**DESCRIPTION**

VCS\_GetVersion returns the firmware version.

**PARAMETERS**

KeyHandle	HANDLE	Handle for port access
NodeId	WORD	Node-ID of the addressed device

**RETURN PARAMETERS**

pHardwareVersion	WORD*	Hardware version
pSoftwareVersion	WORD*	Software version
pApplicationNumber	WORD*	Application number
pApplicationVersion	WORD*	Application version
pErrorCode	DWORD*	Error information on the executed function

<b>Return Value</b>	BOOL	Nonzero if successful; otherwise "0"
---------------------	------	--------------------------------------

## 3.3 Advanced Functions

### 3.3.1 VCS\_GetDeviceNameSelection

**FUNCTION**

BOOL VCS\_GetDeviceNameSelection(BOOL StartOfSelection, char\* pDeviceNameSel, WORD MaxStrSize, BOOL\* pEndOfSelection, DWORD\* pErrorCode)

**DESCRIPTION**

VCS\_GetDeviceNameSelection returns all available device names.

**PARAMETERS**

StartOfSelection	BOOL	True: Get first selection string False: Get next selection string
MaxStrSize	WORD	Reserved memory size for the device name

**RETURN PARAMETERS**

pDeviceNameSel	char*	Device name
pEndOfSelection	BOOL*	True: No more selection string available False: More string available
pErrorCode	DWORD*	Error information on the executed function

<b>Return Value</b>	BOOL	Nonzero if successful; otherwise "0"
---------------------	------	--------------------------------------

**PROGRAMMING EXAMPLE**

```

const WORD maxStrSize = 100;
char* deviceNameSel[maxStrSize];
BOOL endOfSelection = FALSE;
DWORD errorCode = 0;

//get first device name
if(VCS_GetDeviceNameSelection(TRUE, deviceNameSel, maxStrSize, &endOfSelection, &errorCode))
{
    //get next device name (as long as endOfSelection == FALSE)
    while(!endOfSelection)
    {
        VCS_GetDeviceNameSelection(FALSE, deviceNameSel, maxStrSize, &endOfSelection, &errorCode);
    }
}
    
```

Figure 3-10 VCS\_GetDeviceNameSelection (programming example)



### 3.3.2 VCS\_GetProtocolStackNameSelection

#### FUNCTION

BOOL VCS\_GetProtocolStackNameSelection(char\* DeviceName, BOOL StartOfSelection, char\* pProtocolStackNameSel, WORD MaxStrSize, BOOL\* pEndOfSelection, DWORD\* pErrorCode)

#### DESCRIPTION

VCS\_GetProtocolStackNameSelection returns all available protocol stack names.

#### PARAMETERS

DeviceName	char*	Device name
StartOfSelection	BOOL	True: Get first selection string False: Get next selection string
MaxStrSize	WORD	Reserved memory size for the name

#### RETURN PARAMETERS

pProtocolStackNameSel	char*	Pointer to available protocol stack name
pEndOfSelection	BOOL*	True: No more string available False: More string available
pErrorCode	DWORD*	Error information on the executed function

<b>Return Value</b>	BOOL	Nonzero if successful; otherwise "0"
---------------------	------	--------------------------------------

#### PROGRAMMING EXAMPLE

```

const WORD maxStrSize = 100;
char* deviceName = "EPOS2";
char* protocolStackNameSel[maxStrSize];
BOOL endOfSelection = FALSE;
DWORD errorCode = 0;

//get first protocol stack name
if(VCS_GetProtocolStackNameSelection(deviceName,
                                     TRUE, protocolStackNameSel, maxStrSize, &endOfSelection, &errorCode))
{
    //get next protocol stack name (as long as endOfSelection == FALSE)
    while(!endOfSelection)
    {
        VCS_GetProtocolStackNameSelection(deviceName,
                                         FALSE, protocolStackNameSel, maxStrSize, &endOfSelection, &errorCode);
    }
}

```

Figure 3-11 VCS\_GetProtocolStackNameSelection (programming example)

### 3.3.3 VCS\_GetInterfaceNameSelection

**FUNCTION**

BOOL VCS\_GetInterfaceNameSelection(char\* DeviceName, char\* ProtocolStackName, BOOL StartOfSelection, char\* pInterfaceNameSel, WORD MaxStrSize, BOOL\* pEndOfSelection, DWORD\* pErrorCode)

**DESCRIPTION**

VCS\_GetInterfaceNameSelection returns all available interface names.

**PARAMETERS**

DeviceName	char*	Device name
ProtocolStackName	char*	Protocol stack name
StartOfSelection	BOOL	True: Get first selection string False: Get next selection string
MaxStrSize	WORD	Reserved memory size for the interface name

**RETURN PARAMETERS**

pInterfaceNameSel	char*	Name of interface
pEndOfSelection	BOOL*	True: No more string available False: More string available
pErrorCode	DWORD*	Error information on the executed function

<b>Return Value</b>	BOOL	Nonzero if successful; otherwise "0"
---------------------	------	--------------------------------------

**PROGRAMMING EXAMPLE**

```

const WORD maxStrSize = 100;
char* deviceName = "EPOS2";
char* protocolStackName = "MAXON SERIAL V2";
char* interfaceNameSel[maxStrSize];
BOOL endOfSelection = FALSE;
DWORD errorCode = 0;

//get first interface name
if(VCS_GetInterfaceNameSelection(deviceName, protocolStackName,
                                TRUE, interfaceNameSel, maxStrSize, &endOfSelection, &errorCode))
{
    //get next interface name (as long as endOfSelection == FALSE)
    while(!endOfSelection)
    {
        VCS_GetInterfaceNameSelection(deviceName, protocolStackName,
                                      FALSE, interfaceNameSel, maxStrSize, &endOfSelection, &errorCode);
    }
}
    
```

Figure 3-12 VCS\_GetInterfaceNameSelection (programming example)

### 3.3.4 VCS\_GetPortNameSelection

**FUNCTION**

BOOL VCS\_GetPortNameSelection(char\* DeviceName, char\* ProtocolStackName, char\* InterfaceName, BOOL StartOfSelection, char\* pPortSel, WORD MaxStrSize, BOOL\* pEndOfSelection, DWORD\* pErrorCode)

**DESCRIPTION**

VCS\_GetPortNameSelection returns all available port names.

**PARAMETERS**

DeviceName	char*	Device name
ProtocolStackName	char*	Protocol stack name
InterfaceName	char*	Interface name
StartOfSelection	BOOL	True: Get first selection string False: Get next selection string
MaxStrSize	WORD	Reserved memory size for the port name

**RETURN PARAMETERS**

pPortSel	char*	Pointer to port name
pEndOfSelection	BOOL*	True: No more string available False: More string available
pErrorCode	DWORD*	Error information on the executed function

<b>Return Value</b>	BOOL	Nonzero if successful; otherwise "0"
---------------------	------	--------------------------------------

**PROGRAMMING EXAMPLE**

```

const WORD maxStrSize = 100;
char* deviceName = "EPOS2";
char* protocolStackName = "MAXON SERIAL V2";
char* interfaceName = "USB";
char* portSel[maxStrSize];
BOOL endOfSelection = FALSE;
DWORD errorCode = 0;

//get first port name
if(VCS_GetPortNameSelection(deviceName, protocolStackName, interfaceName,
                           TRUE, portSel, maxStrSize, &endOfSelection, &errorCode))
{
    //get next port name (as long as endOfSelection == FALSE)
    while(!endOfSelection)
    {
        VCS_GetPortNameSelection(deviceName, protocolStackName, interfaceName,
                                FALSE, portSel, maxStrSize, &endOfSelection, &errorCode);
    }
}
    
```

Figure 3-13 VCS\_GetPortNameSelection (programming example)

### 3.3.5 VCS\_ResetPortNameSelection

#### FUNCTION

BOOL VCS\_ResetPortNameSelection(char\* DeviceName, char\* ProtocolStackName, char\* InterfaceName, DWORD\* pErrorCode)

#### DESCRIPTION

VCS\_ResetPortNameSelection reinitializes the port enumeration.

#### PARAMETERS

DeviceName	char*	Device name
ProtocolStackName	char*	Protocol stack name
InterfaceName	char*	Interface name

#### RETURN PARAMETERS

pErrorCode	DWORD*	Error information on the executed function
------------	--------	--

<b>Return Value</b>	BOOL	Nonzero if successful; otherwise "0"
---------------------	------	--------------------------------------

### 3.3.6 VCS\_GetBaudRateSelection

**FUNCTION**

BOOL VCS\_GetBaudrateSelection(char\* DeviceName, char\* ProtocolStackName, char\* InterfaceName, char\* PortName, BOOL StartOfSelection, DWORD\* pBaudrateSel, BOOL\* pEndOfSelection, DWORD\* pErrorCode)

**DESCRIPTION**

VCS\_GetBaudrateSelection returns all available baud rates for the connected port.

**PARAMETERS**

DeviceName	char*	Device name
ProtocolStackName	char*	Protocol stack name
InterfaceName	char*	Interface name
PortName	char*	Port name
StartOfSelection	BOOL	True: Get first selection value False: Get next selection value

**RETURN PARAMETERS**

pBaudrateSel	DWORD*	Pointer to baud rate [bit/s]
pEndOfSelection	BOOL*	True: No more value available False: More value available
pErrorCode	DWORD*	Error information on the executed function

<b>Return Value</b>	BOOL	Nonzero if successful; otherwise "0"
---------------------	------	--------------------------------------

**PROGRAMMING EXAMPLE**

```

char* deviceName = "EPOS4";
char* protocolStackName = "MAXON SERIAL V2";
char* interfaceName = "RS232";
char* portName = "COM1";
DWORD baudrateSel;
BOOL endOfSelection = FALSE;
DWORD errorCode = 0;

//get first baudrate
if(VCS_GetBaudrateSelection(deviceName, protocolStackName, interfaceName, portName,
                           TRUE, &baudrateSel, &endOfSelection, &errorCode))
{
    //get next baudrate (as long as endOfSelection == FALSE)
    while(!endOfSelection)
    {
        VCS_GetBaudrateSelection(deviceName, protocolStackName, interfaceName, portName,
                                FALSE, &baudrateSel, &endOfSelection, &errorCode);
    }
}
    
```

Figure 3-14 VCS\_GetBaudrateSelection (programming example)

### 3.3.7 VCS\_GetKeyHandle

**FUNCTION**

BOOL VCS\_GetKeyHandle(char\* DeviceName, char\* ProtocolStackName, char\* InterfaceName, char\* PortName, HANDLE\* pKeyHandle, DWORD\* pErrorCode)

**DESCRIPTION**

VCS\_GetKeyHandle returns the key handle from the opened interface.

**PARAMETERS**

DeviceName	char*	Device name
ProtocolStackName	char*	Protocol stack name
InterfaceName	char*	Interface name
PortName	char*	Port name

**RETURN PARAMETERS**

pKeyHandle	HANDLE*	Handle for port access, if parameters are correct; otherwise 0
pErrorCode	DWORD*	Error information on the executed function

<b>Return Value</b>	BOOL	Nonzero if successful; otherwise "0"
---------------------	------	--------------------------------------

### 3.3.8 VCS\_GetDeviceName

**FUNCTION**

BOOL VCS\_GetDeviceName(HANDLE KeyHandle, char\* pDeviceName, WORD MaxStrSize, DWORD\* pErrorCode)

**DESCRIPTION**

VCS\_GetDeviceName returns the device name to corresponding handle.

**PARAMETERS**

KeyHandle	HANDLE	Handle for port access
MaxStrSize	WORD	Reserved memory size for the device name

**RETURN PARAMETERS**

pDeviceName	char*	Device name
pErrorCode	DWORD*	Error information on the executed function

<b>Return Value</b>	BOOL	Nonzero if successful; otherwise "0"
---------------------	------	--------------------------------------

**3.3.9 VCS\_GetProtocolStackName****FUNCTION**

BOOL VCS\_GetProtocolStackName(HANDLE KeyHandle, char\* pProtocolStackName, WORD MaxStrSize, DWORD\* pErrorCode)

**DESCRIPTION**

VCS\_GetProtocolStackName returns the protocol stack name to corresponding handle.

**PARAMETERS**

KeyHandle	HANDLE	Handle for port access
MaxStrSize	WORD	Reserved memory size for the protocol stack name

**RETURN PARAMETERS**

pProtocolStackName	char*	Pointer to the protocol stack name
pErrorCode	DWORD*	Error information on the executed function

<b>Return Value</b>	BOOL	Nonzero if successful; otherwise "0"
---------------------	------	--------------------------------------

**3.3.10 VCS\_GetInterfaceName****FUNCTION**

BOOL VCS\_GetInterfaceName(HANDLE KeyHandle, char\* pInterfaceName, WORD MaxStrSize, DWORD\* pErrorCode)

**DESCRIPTION**

VCS\_GetInterfaceName returns the interface name to corresponding handle.

**PARAMETERS**

KeyHandle	char*	Handle for port access
MaxStrSize	DWORD*	Reserved memory size for the interface name

**RETURN PARAMETERS**

pInterfaceName	char*	Name of interface
pErrorCode	DWORD*	Error information on the executed function

<b>Return Value</b>	BOOL	Nonzero if successful; otherwise "0"
---------------------	------	--------------------------------------

### 3.3.11 VCS\_GetPortName

#### FUNCTION

BOOL VCS\_GetPortName(HANDLE KeyHandle, char\* pPortName, WORD MaxStrSize, DWORD\* pErrorCode)

#### DESCRIPTION

VCS\_GetPortName returns the port name to corresponding handle.

#### PARAMETERS

KeyHandle	char*	Handle for port access
MaxStrSize	DWORD*	Reserved memory size for the port name

#### RETURN PARAMETERS

pPortName	char*	Port name
pErrorCode	DWORD*	Error information on the executed function

<b>Return Value</b>	BOOL	Nonzero if successful; otherwise "0"
---------------------	------	--------------------------------------



## 4 Configuration Functions

For detailed information on the objects → separate document «Firmware Specification».



### Availability of functions

The availability of certain functions depends on the used hardware. For an overview → “Appendix A — Hardware vs. Functions” on page 11-161.

### 4.1 General

#### 4.1.1 VCS\_ImportParameter

##### FUNCTION

BOOL VCS\_ImportParameter(HANDLE KeyHandle, WORD NodeId, char\* pParameterFileName, BOOL ShowDlg, BOOL ShowMsg, DWORD\* pErrorCode)

##### DESCRIPTION

VCS\_ImportParameter writes parameters from a file to the device. Not available with Linux.

##### PARAMETERS

KeyHandle	HANDLE	Handle for port access
NodeId	WORD	Node-ID of the addressed device
pParameterFileName	char*	Full path of parameter file for import
ShowDlg	BOOL	Dialog is shown
ShowMsg	BOOL	Message box are activated

##### RETURN PARAMETERS

pErrorCode	DWORD*	Error information on the executed function
------------	--------	--

<b>Return Value</b>	BOOL	Nonzero if successful; otherwise “0”
---------------------	------	--------------------------------------

##### PROGRAMMING EXAMPLE

```
HANDLE keyHandle = 0;
WORD nodeId = 1;
char* parameterFileName = "C:\\Files\\Parameters.dcf";
BOOL showDlg = TRUE;
BOOL showMsg = FALSE;
DWORD errorCode = 0;
BOOL result = FALSE;

//...
result = VCS_ImportParameter(keyHandle, nodeId, parameterFileName, showDlg, showMsg, &errorCode);
//...
```

Figure 4-15 VCS\_ImportParameter (programming example)

## 4.1.2 VCS\_ExportParameter

### FUNCTION

BOOL VCS\_ExportParameter(HANDLE KeyHandle, WORD NodeId, char\* pParameterFileName, char\* pFirmwareFileName, char\* pUserID, char\* pComment, BOOL ShowDlg, BOOL ShowMsg, DWORD\* pErrorCode)

### DESCRIPTION

VCS\_ExportParameter reads all device parameters and writes them to the file. Not available with Linux.

### PARAMETERS

KeyHandle	HANDLE	Handle for port access
NodeId	WORD	Node-ID of the addressed device
pParameterFileName	char*	Full path of parameter file for export
pFirmwareFileName	char*	Full path of firmware file of connected device
pUserID	char*	User name
pComment	char*	Comment
ShowDlg	BOOL	Dialog is shown
ShowMsg	BOOL	Message box are activated

### RETURN PARAMETERS

pErrorCode	DWORD*	Error information on the executed function
------------	--------	--

<b>Return Value</b>	BOOL	Nonzero if successful; otherwise "0"
---------------------	------	--------------------------------------

### PROGRAMMING EXAMPLE

```

HANDLE keyHandle = 0;
WORD nodeId = 1;
char* parameterFileName = "C:\\Files\\Parameters.dcf";
char* firmwareFileName = "C:\\Files\\Epos_2126h_6220h_0000h_0000h.bin";
char* userId = "Hans Muster";
char* comment = "Parameter Backup";
BOOL showDlg = TRUE;
BOOL showMsg = FALSE;
DWORD errorCode = 0;
BOOL result = FALSE;

//...
result = VCS_ExportParameter(keyHandle, nodeId, parameterFileName, firmwareFileName,
                             userId, comment, showDlg, showMsg, &errorCode);
//...
    
```

Figure 4-16 VCS\_ExportParameter (programming example)

**4.1.3 VCS\_SetObject****FUNCTION**

BOOL VCS\_SetObject(HANDLE KeyHandle, WORD NodeId, WORD ObjectIndex, BYTE ObjectSubIndex, void\* pData, DWORD NbOfBytesToWrite, DWORD\* pNbOfBytesWritten, DWORD\* pErrorCode)

**DESCRIPTION**

VCS\_SetObject writes an object value at the given index and subindex.

For information on object index, object subindex, and object length → separate document «Firmware Specification».

**PARAMETERS**

KeyHandle	HANDLE	Handle for port access
NodeId	WORD	Node-ID of the addressed device
ObjectIndex	WORD	Object index
ObjectSubIndex	BYTE	Object subindex
pData	void*	Object data
NbOfBytesToWrite	DWORD	Object length to write (number of bytes)

**RETURN PARAMETERS**

pNbOfBytesWritten	DWORD*	Object length written (number of bytes)
pErrorCode	DWORD*	Error information on the executed function

<b>Return Value</b>	BOOL	Nonzero if successful; otherwise "0"
---------------------	------	--------------------------------------

### 4.1.4 VCS\_GetObject

**FUNCTION**

BOOL VCS\_GetObject(HANDLE KeyHandle, WORD NodeId, WORD ObjectIndex, BYTE ObjectSubIndex, void\* pData, DWORD NbOfBytesToRead, DWORD\* pNbOfBytesRead, DWORD\* pErrorCode)

**DESCRIPTION**

VCS\_GetObject reads an object value at the given index and subindex.

For information on object index, object subindex, and object length → separate document «Firmware Specification».

**PARAMETERS**

KeyHandle	HANDLE	Handle for port access
NodeId	WORD	Node-ID of the addressed device
ObjectIndex	WORD	Object index
ObjectSubIndex	BYTE	Object subindex
NbOfBytesToRead	DWORD	Object length to read (number of bytes)

**RETURN PARAMETERS**

pData	void*	Object data
pNbOfBytesRead	DWORD*	Object length read (number of bytes)
pErrorCode	DWORD*	Error information on the executed function

<b>Return Value</b>	BOOL	Nonzero if successful; otherwise "0"
---------------------	------	--------------------------------------

### 4.1.5 VCS\_Restore

**FUNCTION**

BOOL VCS\_Restore(HANDLE KeyHandle, WORD NodeId, DWORD\* pErrorCode)

**DESCRIPTION**

VCS\_Restore restores all default parameters.

**PARAMETERS**

KeyHandle	HANDLE	Handle for port access
NodeId	WORD	Node-ID of the addressed device

**RETURN PARAMETERS**

pErrorCode	DWORD*	Error information on the executed function
------------	--------	--

<b>Return Value</b>	BOOL	Nonzero if successful; otherwise "0"
---------------------	------	--------------------------------------

#### 4.1.6 VCS\_Store

**FUNCTION**

BOOL VCS\_Store(HANDLE KeyHandle, WORD NodeId, DWORD\* pErrorCode)

**DESCRIPTION**

VCS\_Store stores all parameters.

**PARAMETERS**

KeyHandle	HANDLE	Handle for port access
NodeId	WORD	Node-ID of the addressed device

**RETURN PARAMETERS**

pErrorCode	DWORD*	Error information on the executed function
------------	--------	--

<b>Return Value</b>	BOOL	Nonzero if successful; otherwise "0"
---------------------	------	--------------------------------------

#### 4.1.7 VCS\_UpdateFirmware

**FUNCTION**

BOOL VCS\_UpdateFirmware (HANDLE KeyHandle, WORD NodeId, char \*pBinaryFile, BOOL ShowDlg, BOOL ShowHistory, BOOL ShowMsg, DWORD \*pErrorCode)

**DESCRIPTION**

VCS\_UpdateFirmware is used to update the binary code for the controller firmware. Not available with Linux.

**PARAMETERS**

KeyHandle	HANDLE	Handle for port access
NodeId	WORD	Identification ID of the addressed device
pBinaryFile	char*	Full path of firmware file
ShowDlg	BOOL	Progress dialog is shown
ShowHistory	BOOL	History list is shown in the progress dialog
ShowMsg	BOOL	Message boxes are shown during download (for example if an error occurs)

**RETURN PARAMETERS**

pErrorCode	DWORD*	Error information on the executed function
------------	--------	--

<b>Return Value</b>	BOOL	Nonzero if successful; otherwise "0"
---------------------	------	--------------------------------------

**PROGRAMMING EXAMPLE**

```
HANDLE keyHandle = 0;
WORD nodeId = 1;
char* binaryFileName = "C:\\Files\\Epos_2126h_6220h_0000h_0000h.bin";
BOOL showDlg = TRUE;
BOOL showHistory = TRUE;
BOOL showMsg = FALSE;
DWORD errorCode = 0;
BOOL result = FALSE;

//...
result = VCS_UpdateFirmware(keyHandle, nodeId, binaryFileName,
                           showDlg, showHistory, showMsg, &errorCode);
//...
```

Figure 4-17 VCS\_UpdateFirmware (programming example)

## 4.2 Advanced Functions

### 4.2.1 Motor

#### 4.2.1.1 VCS\_SetMotorType

**FUNCTION**

BOOL VCS\_SetMotorType(HANDLE KeyHandle, WORD NodeId, WORD MotorType, DWORD\* pErrorCode)

**DESCRIPTION**

VCS\_SetMotorType writes the motor type.

**PARAMETERS**

KeyHandle	HANDLE	Handle for port access
NodeId	WORD	Node-ID of the addressed device
MotorType	WORD	Type of motor (→ Table 4-6)

**RETURN PARAMETERS**

pErrorCode	DWORD*	Error information on the executed function
------------	--------	--

<b>Return Value</b>	BOOL	Nonzero if successful; otherwise "0"
---------------------	------	--------------------------------------

Description	Value	Name
brushed DC motor	1	MT_DC_MOTOR
EC motor sinus commutated	10	MT_EC_SINUS_COMMUTATED_MOTOR
EC motor block commutated	11	MT_EC_BLOCK_COMMUTATED_MOTOR

Table 4-6 Motor types

#### 4.2.1.2 VCS\_SetDcMotorParameter

**FUNCTION**

BOOL VCS\_SetDcMotorParameter(HANDLE KeyHandle, WORD NodeId, WORD NominalCurrent, WORD MaxOutputCurrent, WORD ThermalTimeConstant, DWORD\* pErrorCode)

**DESCRIPTION**

VCS\_SetDcMotorParameter writes all DC motor parameters.

**PARAMETERS**

KeyHandle	HANDLE	Handle for port access
NodeId	WORD	Node-ID of the addressed device
NominalCurrent	WORD	Maximal continuous current
MaxOutputCurrent	WORD	Maximal peak current
ThermalTimeConstant	WORD	Thermal time constant winding

**RETURN PARAMETERS**

pErrorCode	DWORD*	Error information on the executed function
------------	--------	--

<b>Return Value</b>	BOOL	Nonzero if successful; otherwise "0"
---------------------	------	--------------------------------------

### 4.2.1.3 VCS\_SetEcMotorParameter

**FUNCTION**

BOOL VCS\_SetEcMotorParameter(HANDLE KeyHandle, WORD NodeId, WORD NominalCurrent, WORD MaxOutputCurrent, WORD ThermalTimeConstant, BYTE NbOfPolePairs, DWORD\* pErrorCode)

**DESCRIPTION**

VCS\_SetEcMotorParameter writes all EC motor parameters.

**PARAMETERS**

KeyHandle	HANDLE	Handle for port access
NodeId	WORD	Node-ID of the addressed device
NominalCurrent	WORD	Maximal continuous current
MaxOutputCurrent	WORD	Maximal peak current
ThermalTimeConstant	WORD	Thermal time constant winding
NbOfPolePairs	BYTE	Number of pole pairs

**RETURN PARAMETERS**

pErrorCode	DWORD*	Error information on the executed function
------------	--------	--

<b>Return Value</b>	BOOL	Nonzero if successful; otherwise "0"
---------------------	------	--------------------------------------

### 4.2.1.4 VCS\_GetMotorType

**FUNCTION**

BOOL VCS\_GetMotorType(HANDLE KeyHandle, WORD NodeId, WORD\* pMotorType, DWORD\* pErrorCode)

**DESCRIPTION**

VCS\_GetMotorType reads the motor type.

**PARAMETERS**

KeyHandle	HANDLE	Handle for port access
NodeId	WORD	Node-ID of the addressed device

**RETURN PARAMETERS**

pMotorType	WORD*	Type of motor (→ Table 4-6)
pErrorCode	DWORD*	Error information on the executed function

<b>Return Value</b>	BOOL	Nonzero if successful; otherwise "0"
---------------------	------	--------------------------------------

### 4.2.1.5 VCS\_GetDcMotorParameter

**FUNCTION**

BOOL VCS\_GetDcMotorParameter(HANDLE KeyHandle, WORD NodeId, WORD\* pNominalCurrent, WORD\* pMaxOutputCurrent, WORD\* pThermalTimeConstant, DWORD\* pErrorCode)

**DESCRIPTION**

VCS\_GetDcMotorParameter reads all DC motor parameters.

**PARAMETERS**

KeyHandle	HANDLE	Handle for port access
NodeId	WORD	Node-ID of the addressed device

**RETURN PARAMETERS**

pNominalCurrent	WORD*	Maximal continuous current
pMaxOutputCurrent	WORD*	Maximal peak current
pThermalTimeConstant	WORD*	Thermal time constant winding
pErrorCode	DWORD*	Error information on the executed function

<b>Return Value</b>	BOOL	Nonzero if successful; otherwise "0"
---------------------	------	--------------------------------------

### 4.2.1.6 VCS\_GetEcMotorParameter

**FUNCTION**

BOOL VCS\_GetEcMotorParameter(HANDLE KeyHandle, WORD NodeId, WORD\* pNominalCurrent, WORD\* pMaxOutputCurrent, WORD\* pThermalTimeConstant, BYTE\* pNbOfPolePairs, DWORD\* pErrorCode)

**DESCRIPTION**

VCS\_GetEcMotorParameter reads all EC motor parameters.

**PARAMETERS**

KeyHandle	HANDLE	Handle for port access
NodeId	WORD	Node-ID of the addressed device

**RETURN PARAMETERS**

pNominalCurrent	WORD*	Maximal continuous current
pMaxOutputCurrent	WORD*	Maximal peak current
pThermalTimeConstant	WORD*	Thermal time constant winding
pNbOfPolePairs	BYTE*	Number of pole pairs
pErrorCode	DWORD*	Error information on the executed function

<b>Return Value</b>	BOOL	Nonzero if successful; otherwise "0"
---------------------	------	--------------------------------------



4.2.2 Sensor

4.2.2.1 VCS\_SetSensorType

FUNCTION

BOOL VCS\_SetSensorType(HANDLE KeyHandle, WORD NodeId, WORD SensorType, DWORD\* pErrorCode)

DESCRIPTION

VCS\_SetSensorType writes the sensor type.

PARAMETERS

KeyHandle	HANDLE	Handle for port access
NodeId	WORD	Node-ID of the addressed device
SensorType	WORD	Position Sensor Type (→Table 4-7)

RETURN PARAMETERS

pErrorCode	DWORD*	Error information on the executed function
------------	--------	--

<b>Return Value</b>	BOOL	Nonzero if successful; otherwise "0"
---------------------	------	--------------------------------------

Description	Value	Name
Unknown / No sensor	0	ST_UNKNOWN
Incremental encoder 1 with index (3-channel)	1	ST_INC_ENCODER_3CHANNEL
Incremental encoder 1 without index (2-channel)	2	ST_INC_ENCODER_2CHANNEL
Hall Sensors	3	ST_HALL_SENSORS
SSI encoder binary coded	4	ST_SSI_ABS_ENCODER_BINARY
SSI encoder Grey coded	5	ST_SSI_ABS_ENCODER_GREY
Incremental encoder 2 with index (3-channel)	6	ST_INC_ENCODER2_3CHANNEL
Incremental encoder 2 without index (2-channel)	7	ST_INC_ENCODER2_2CHANNEL
Analog incremental encoder with index (3-channel)	8	ST_ANALOG_INC_ENCODER_3CHANNEL
Analog incremental encoder without index (2-channel)	9	ST_ANALOG_INC_ENCODER_2CHANNEL

Table 4-7 Position sensor types

### 4.2.2.2 VCS\_SetIncEncoderParameter

**FUNCTION**

BOOL VCS\_SetIncEncoderParameter(HANDLE KeyHandle, WORD NodeId, DWORD EncoderResolution, BOOL InvertedPolarity, DWORD\* pErrorCode)

**DESCRIPTION**

VCS\_SetIncEncoderParameter writes the incremental encoder parameters.

**PARAMETERS**

KeyHandle	HANDLE	Handle for port access
NodeId	WORD	Node-ID of the addressed device
EncoderResolution	DWORD	Encoder pulse number [pulse per turn]
InvertedPolarity	BOOL	Position sensor polarity

**RETURN PARAMETERS**

pErrorCode	DWORD*	Error information on the executed function
------------	--------	--

<b>Return Value</b>	BOOL	Nonzero if successful; otherwise "0"
---------------------	------	--------------------------------------

### 4.2.2.3 VCS\_SetHallSensorParameter

**FUNCTION**

BOOL VCS\_SetHallSensorParameter(HANDLE KeyHandle, WORD NodeId, BOOL InvertedPolarity, DWORD\* pErrorCode)

**DESCRIPTION**

VCS\_SetHallSensorParameter writes the Hall sensor parameter.

**PARAMETERS**

KeyHandle	HANDLE	Handle for port access
NodeId	WORD	Node-ID of the addressed device
InvertedPolarity	BOOL	Position sensor polarity

**RETURN PARAMETERS**

pErrorCode	DWORD*	Error information on the executed function
------------	--------	--

<b>Return Value</b>	BOOL	Nonzero if successful; otherwise "0"
---------------------	------	--------------------------------------

#### 4.2.2.4 VCS\_SetSsiAbsEncoderParameterEx

**FUNCTION**

BOOL VCS\_SetSsiAbsEncoderParameterEx(HANDLE KeyHandle, WORD NodeId, WORD DataRate, WORD NbOfMultiTurnDataBits, WORD NbOfSingleTurnDataBits, WORD NbOfSpecialDataBits, BOOL InvertedPolarity, WORD Timeout, WORD PowerupTime, DWORD\* pErrorCode)

**DESCRIPTION**

VCS\_SetSsiAbsEncoderParameterEx writes all parameters for EPOS4 SSI absolute encoder.

**PARAMETERS**

KeyHandle	HANDLE	Handle for port access
NodeId	WORD	Node-ID of the addressed device
DataRate	WORD	SSI encoder data rate
NbOfMultiTurnDataBits	WORD	Number of bits multi turn
NbOfSingleTurnDataBits	WORD	Number of bits single turn
NbOfSpecialDataBits	WORD	Number of bits special data
InvertedPolarity	BOOL	Position sensor polarity
Timeout	WORD	Timeout time
PowerupTime	WORD	Power up time

**RETURN PARAMETERS**

pErrorCode	DWORD*	Error information on the executed function
------------	--------	--

<b>Return Value</b>	BOOL	Nonzero if successful; otherwise "0"
---------------------	------	--------------------------------------

#### 4.2.2.5 VCS\_SetSsiAbsEncoderParameter

**FUNCTION**

BOOL VCS\_SetSsiAbsEncoderParameter(HANDLE KeyHandle, WORD NodeId, WORD DataRate, WORD NbOfMultiTurnDataBits, WORD NbOfSingleTurnDataBits, BOOL InvertedPolarity, DWORD\* pErrorCode)

**DESCRIPTION**

VCS\_SetSsiAbsEncoderParameter writes all parameters for SSI absolute encoder.

**PARAMETERS**

KeyHandle	HANDLE	Handle for port access
NodeId	WORD	Node-ID of the addressed device
DataRate	WORD	SSI encoder data rate
NbOfMultiTurnDataBits	WORD	Number of bits multi turn
NbOfSingleTurnDataBits	WORD	Number of bits single turn
InvertedPolarity	BOOL	Position sensor polarity

**RETURN PARAMETERS**

pErrorCode	DWORD*	Error information on the executed function
------------	--------	--

<b>Return Value</b>	BOOL	Nonzero if successful; otherwise "0"
---------------------	------	--------------------------------------

### 4.2.2.6 VCS\_GetSensorType

**FUNCTION**

BOOL VCS\_GetSensorType(HANDLE KeyHandle, WORD NodeId, WORD\* pSensorType, DWORD\* pErrorCode)

**DESCRIPTION**

VCS\_GetSensorType reads the sensor type.

**PARAMETERS**

KeyHandle	HANDLE	Handle for port access
NodeId	WORD	Node-ID of the addressed device

**RETURN PARAMETERS**

pSensorType	WORD*	Position sensor type (→ Table 4-7)
pErrorCode	DWORD*	Error information on the executed function

<b>Return Value</b>	BOOL	Nonzero if successful; otherwise "0"
---------------------	------	--------------------------------------

### 4.2.2.7 VCS\_GetIncEncoderParameter

**FUNCTION**

BOOL VCS\_GetIncEncoderParameter(HANDLE KeyHandle, WORD NodeId, DWORD\* pEncoderResolution, BOOL\* pInvertedPolarity, DWORD\* pErrorCode)

**DESCRIPTION**

VCS\_GetIncEncoderParameter reads the incremental encoder parameters.

**PARAMETERS**

KeyHandle	HANDLE	Handle for port access
NodeId	WORD	Node-ID of the addressed device

**RETURN PARAMETERS**

pEncoderResolution	DWORD*	Encoder pulse number [pulse per turn]
pInvertedPolarity	BOOL*	Position sensor polarity
pErrorCode	DWORD*	Error information on the executed function

<b>Return Value</b>	BOOL	Nonzero if successful; otherwise "0"
---------------------	------	--------------------------------------

**4.2.2.8 VCS\_GetHallSensorParameter****FUNCTION**

BOOL VCS\_GetHallSensorParameter(HANDLE KeyHandle, WORD NodeId, BOOL\* pInvertedPolarity, DWORD\* pErrorCode)

**DESCRIPTION**

VCS\_GetHallSensorParameter reads the Hall sensor parameters.

**PARAMETERS**

KeyHandle	HANDLE	Handle for port access
NodeId	WORD	Node-ID of the addressed device

**RETURN PARAMETERS**

pInvertedPolarity	BOOL*	Position sensor polarity
pErrorCode	DWORD*	Error information on the executed function

<b>Return Value</b>	BOOL	Nonzero if successful; otherwise "0"
---------------------	------	--------------------------------------

**4.2.2.9 VCS\_GetSsiAbsEncoderParameter****FUNCTION**

BOOL VCS\_GetSsiAbsEncoderParameter(HANDLE KeyHandle, WORD NodeId, WORD\* pDataRate, WORD\* pNbOfMultiTurnDataBits, WORD\* pNbOfSingleTurnDataBits, BOOL\* pInvertedPolarity, DWORD\* pErrorCode)

**DESCRIPTION**

VCS\_GetSsiAbsEncoderParameter reads all parameters from SSI absolute encoder.

**PARAMETERS**

KeyHandle	HANDLE	Handle for port access
NodeId	WORD	Node-ID of the addressed device

**RETURN PARAMETERS**

pDataRate	WORD*	SSI encoder data rate
pNbOfMultiTurnDataBits	WORD*	Number of bits multi turn
pNbOfSingleTurnDataBits	WORD*	Number of bits single turn
pInvertedPolarity	BOOL*	Position sensor polarity
pErrorCode	DWORD*	Error information on the executed function

<b>Return Value</b>	BOOL	Nonzero if successful; otherwise "0"
---------------------	------	--------------------------------------

### 4.2.2.10 VCS\_GetSsiAbsEncoderParameterEx

**FUNCTION**

BOOL VCS\_GetSsiAbsEncoderParameterEx(HANDLE KeyHandle, WORD NodeId, WORD\* pDataRate, WORD\* pNbOfMultiTurnDataBits, WORD\* pNbOfSingleTurnDataBits, WORD\* pNbOfSpecialDataBits, BOOL\* pInvertedPolarity, WORD\* pTimeout, WORD\* pPowerupTime, DWORD\* pErrorCode)

**DESCRIPTION**

VCS\_GetSsiAbsEncoderParameterEx reads all parameters from EPOS4 SSI absolute encoder.

**PARAMETERS**

KeyHandle	HANDLE	Handle for port access
NodeId	WORD	Node-ID of the addressed device

**RETURN PARAMETERS**

pDataRate	WORD*	SSI encoder data rate
pNbOfMultiTurnDataBits	WORD*	Number of bits multi turn
pNbOfSingleTurnDataBits	WORD*	Number of bits single turn
pNbOfSpecialDataBits	WORD*	Number of bits special data
pInvertedPolarity	BOOL*	Position sensor polarity
pTimeout	WORD*	Timeout time
pPowerupTime	WORD*	Power up time
pErrorCode	DWORD*	Error information on the executed function

<b>Return Value</b>	BOOL	Nonzero if successful; otherwise "0"
---------------------	------	--------------------------------------

**4.2.3 Safety****4.2.3.1 VCS\_SetMaxFollowingError****FUNCTION**

BOOL VCS\_SetMaxFollowingError(HANDLE KeyHandle, WORD NodeId, DWORD MaxFollowingError, DWORD\* pErrorCode)

**DESCRIPTION**

VCS\_SetMaxFollowingError writes the maximal allowed following error parameter.

**PARAMETERS**

KeyHandle	HANDLE	Handle for port access
NodeId	WORD	Node-ID of the addressed device
MaxFollowingError	DWORD	Maximal allowed difference of position actual value to position demand value

**RETURN PARAMETERS**

pErrorCode	DWORD*	Error information on the executed function
------------	--------	--

<b>Return Value</b>	BOOL	Nonzero if successful; otherwise "0"
---------------------	------	--------------------------------------

**4.2.3.2 VCS\_GetMaxFollowingError****FUNCTION**

BOOL VCS\_GetMaxFollowingError(HANDLE KeyHandle, WORD NodeId, DWORD\* pMaxFollowingError, DWORD\* pErrorCode)

**DESCRIPTION**

VCS\_GetMaxFollowingError reads the maximal allowed following error parameter.

**PARAMETERS**

KeyHandle	HANDLE	Handle for port access
NodeId	WORD	Node-ID of the addressed device

**RETURN PARAMETERS**

pMaxFollowingError	DWORD*	Maximal allowed difference of position actual value to position demand value
pErrorCode	DWORD*	Error information on the executed function

<b>Return Value</b>	BOOL	Nonzero if successful; otherwise "0"
---------------------	------	--------------------------------------

### 4.2.3.3 VCS\_SetMaxProfileVelocity

**FUNCTION**

BOOL VCS\_SetMaxProfileVelocity(HANDLE KeyHandle, WORD NodeId, DWORD MaxProfileVelocity, DWORD\* pErrorCode)

**DESCRIPTION**

VCS\_SetMaxProfileVelocity writes the maximal allowed velocity. The velocity is interpreted according to the currently configured velocity unit.

**PARAMETERS**

KeyHandle	HANDLE	Handle for port access
NodeId	WORD	Node-ID of the addressed device
MaxProfileVelocity	DWORD	Used as velocity limit in a position (or velocity) move

**RETURN PARAMETERS**

pErrorCode	DWORD*	Error information on the executed function
------------	--------	--

<b>Return Value</b>	BOOL	Nonzero if successful; otherwise "0"
---------------------	------	--------------------------------------

### 4.2.3.4 VCS\_GetMaxProfileVelocity

**FUNCTION**

BOOL VCS\_GetMaxProfileVelocity(HANDLE KeyHandle, WORD NodeId, DWORD\* pMaxProfileVelocity, DWORD\* pErrorCode)

**DESCRIPTION**

VCS\_GetMaxProfileVelocity reads the maximal allowed velocity. The velocity is interpreted according to the currently configured velocity unit.

**PARAMETERS**

KeyHandle	HANDLE	Handle for port access
NodeId	WORD	Node-ID of the addressed device

**RETURN PARAMETERS**

pMaxProfileVelocity	DWORD*	Used as velocity limit in a position (or velocity) move
pErrorCode	DWORD*	Error information on the executed function

<b>Return Value</b>	BOOL	Nonzero if successful; otherwise "0"
---------------------	------	--------------------------------------



**4.2.3.5 VCS\_SetMaxAcceleration****FUNCTION**

BOOL VCS\_SetMaxAcceleration(HANDLE KeyHandle, WORD NodeId, DWORD MaxAcceleration, DWORD\* pErrorCode)

**DESCRIPTION**

VCS\_SetMaxAcceleration writes the maximal allowed acceleration/deceleration.

**PARAMETERS**

KeyHandle	HANDLE	Handle for port access
NodeId	WORD	Node-ID of the addressed device
MaxAcceleration	DWORD	Limiter of the other acceleration/ deceleration objects

**RETURN PARAMETERS**

pErrorCode	DWORD*	Error information on the executed function
------------	--------	--

<b>Return Value</b>	BOOL	Nonzero if successful; otherwise "0"
---------------------	------	--------------------------------------

**4.2.3.6 VCS\_GetMaxAcceleration****FUNCTION**

BOOL VCS\_GetMaxAcceleration(HANDLE KeyHandle, WORD NodeId, DWORD\* pMaxAcceleration, DWORD\* pErrorCode)

**DESCRIPTION**

VCS\_GetMaxAcceleration reads the maximal allowed acceleration/deceleration.

**PARAMETERS**

KeyHandle	HANDLE	Handle for port access
NodeId	WORD	Node-ID of the addressed device

**RETURN PARAMETERS**

pMaxAcceleration	DWORD*	Limiter of the other acceleration/deceleration objects
pErrorCode	DWORD*	Error information on the executed function

<b>Return Value</b>	BOOL	Nonzero if successful; otherwise "0"
---------------------	------	--------------------------------------

## 4.2.4 Controller Gain

### 4.2.4.1 VCS\_SetControllerGain

**FUNCTION**

VCS\_SetControllerGain(HANDLE KeyHandle, WORD NodeId, WORD EController, WORD EGain, DWORD64 Value, DWORD\* pErrorCode)

**DESCRIPTION**

VCS\_SetControllerGain writes the controller gain.

**PARAMETERS**

KeyHandle	HANDLE	Handle for port access
NodeId	WORD	Node-ID of the addressed device
EController	WORD	Regulation controller (→Table 4-8)
EGain	WORD	Regulation gain (→Table 4-9 thru Table 4-13)
Value	DWORD64	Regulation value

**RETURN PARAMETERS**

pErrorCode	DWORD*	Error information on the executed function
------------	--------	--

<b>Return Value</b>	BOOL	Nonzero if successful; otherwise "0"
---------------------	------	--------------------------------------

### 4.2.4.2 VCS\_GetControllerGain

**FUNCTION**

VCS\_GetControllerGain(HANDLE KeyHandle, WORD NodeId, WORD EController, WORD EGain, DWORD64\* pValue, DWORD\* pErrorCode)

**DESCRIPTION**

VCS\_GetControllerGain reads the controller gain.

**PARAMETERS**

KeyHandle	HANDLE	Handle for port access
NodeId	WORD	Node-ID of the addressed device
EController	WORD	Regulation controller (→Table 4-8)
EGain	WORD	Regulation gain (→Table 4-9 thru Table 4-13)

**RETURN PARAMETERS**

pValue	DWORD64	Regulation value
pErrorCode	DWORD*	Error information on the executed function

<b>Return Value</b>	BOOL	Nonzero if successful; otherwise "0"
---------------------	------	--------------------------------------

Continued on next page.

Description	Value	Name
PI current controller	1	EC_PI_CURRENT_CONTROLLER
PI velocity controller	10	EC_PI_VELOCITY_CONTROLLER
PI velocity controller with observer	11	EC_PI_VELOCITY_CONTROLLER_WITH_OBSERVER
PID position controller	20	EC_PID_POSITION_CONTROLLER
Dual loop position controller	21	EC_DUAL_LOOP_POSITION_CONTROLLER

Table 4-8 Controller Gain – Regulation controller

Description	Value	Name
Current controller P gain	1	EG_PICC_P_GAIN
Current controller I gain	2	EG_PICC_I_GAIN

Table 4-9 Controller Gain – PI current controller gains

Description	Value	Name
Velocity controller P gain	1	EG_PIVC_P_GAIN
Velocity controller I gain	2	EG_PIVC_I_GAIN
Velocity controller FF acceleration gain	10	EG_PIVC_FEED_FORWARD_VELOCITY_GAIN
Velocity controller FF acceleration gain	11	EG_PIVC_FEED_FORWARD_ACCELERATION_GAIN

Table 4-10 Controller Gain – PI velocity controller gains

Description	Value	Name
Velocity controller P gain	1	EG_PIVCWO_P_GAIN
Velocity controller I gain	2	EG_PIVCWO_I_GAIN
Velocity controller FF acceleration gain	10	EG_PIVCWO_FEED_FORWARD_VELOCITY_GAIN
Velocity controller FF acceleration gain	11	EG_PIVCWO_FEED_FORWARD_ACCELERATION_GAIN
Velocity observer position correction gain	20	EG_PIVCWO_OBSERVER_THETA_GAIN
Velocity observer velocity correction gain	21	EG_PIVCWO_OBSERVER_OMEGA_GAIN
Velocity observer load correction gain	22	EG_PIVCWO_OBSERVER_TAU_GAIN

Table 4-11 Controller Gain – PI velocity controller gains with observer

Continued on next page.

Description	Value	Name
Position controller P gain	1	EG_PIDPC_P_GAIN
Position controller I gain	2	EG_PIDPC_I_GAIN
Position controller D gain	3	EG_PIDPC_D_GAIN
Position controller FF velocity gain	10	EG_PIDPC_FEED_FORWARD_VELOCITY_GAIN
Position controller FF acceleration gain	11	EG_PIDPC_FEED_FORWARD_ACCELERATION_GAIN

Table 4-12 Controller Gain – PID position controller gains

Description	Value	Name
Auxiliary loop P gain	1	EG_DLPC_AUXILIARY_LOOP_P_GAIN
Auxiliary loop I gain	2	EG_DLPC_AUXILIARY_LOOP_I_GAIN
Auxiliary loop FF velocity gain	10	EG_DLPC_AUXILIARY_LOOP_FEED_FORWARD_VELOCITY_GAIN
Auxiliary loop FF acceleration gain	11	EG_DLPC_AUXILIARY_LOOP_FEED_FORWARD_ACCELERATION_GAIN
Auxiliary loop observer position correction gain	20	EG_DLPC_AUXILIARY_LOOP_OBSERVER_THETA_GAIN
Auxiliary loop observer velocity correction gain	21	EG_DLPC_AUXILIARY_LOOP_OBSERVER_OMEGA_GAIN
Auxiliary loop observer load correction gain	22	EG_DLPC_AUXILIARY_LOOP_OBSERVER_TAU_GAIN
Main loop P gain low	101	EG_DLPC_MAIN_LOOP_P_GAIN_LOW
Main loop P gain high	102	EG_DLPC_MAIN_LOOP_P_GAIN_HIGH
Main loop gain scheduling weight	110	EG_DLPC_MAIN_LOOP_GAIN_SCHEDULING_WEIGHT
Main loop filter coefficient A	120	EG_DLPC_MAIN_LOOP_FILTER_COEFFICIENT_A
Main loop filter coefficient B	121	EG_DLPC_MAIN_LOOP_FILTER_COEFFICIENT_B
Main loop filter coefficient C	122	EG_DLPC_MAIN_LOOP_FILTER_COEFFICIENT_C
Main loop filter coefficient D	123	EG_DLPC_MAIN_LOOP_FILTER_COEFFICIENT_D
Main loop filter coefficient E	124	EG_DLPC_MAIN_LOOP_FILTER_COEFFICIENT_E

Table 4-13 Controller Gain – Dual loop controller gains

4.2.5 Inputs/Outputs

4.2.5.1 VCS\_DigitalInputConfiguration

FUNCTION

BOOL VCS\_DigitalInputConfiguration(HANDLE KeyHandle, WORD NodeId, WORD DigitalInputNb, WORD Configuration, BOOL Mask, BOOL Polarity, BOOL ExecutionMask, DWORD\* pErrorCode)

DESCRIPTION

VCS\_DigitalInputConfiguration sets the parameter for one digital input.

PARAMETERS

KeyHandle	HANDLE	Handle for port access
NodeId	WORD	Node-ID of the addressed device
DigitalInputNb	WORD	Number of digital input (object subindex)
Configuration	WORD	Configures the functionality assigned to the digital input (bit number) (→ Table 4-14)
Mask	BOOL	1: Functionality state will be displayed 0: not displayed (not supported for EPOS4)
Polarity	BOOL	1: Low active 0: High active
ExecutionMask	BOOL	1: Set the error routine Only for positive and negative switch

RETURN PARAMETERS

pErrorCode	DWORD*	Error information on the executed function
------------	--------	--

<b>Return Value</b>	BOOL	Nonzero if successful; otherwise "0"
---------------------	------	--------------------------------------

Description	Value	Name
None	255	DIC_NO_FUNCTIONALITY
General purpose A	15	DIC_GENERAL_PURPOSE_A
General purpose B	14	DIC_GENERAL_PURPOSE_B
General purpose C	13	DIC_GENERAL_PURPOSE_C
General purpose D	12	DIC_GENERAL_PURPOSE_D
General purpose E	11	DIC_GENERAL_PURPOSE_E
General purpose F	10	DIC_GENERAL_PURPOSE_F
General purpose G	9	DIC_GENERAL_PURPOSE_G
General purpose H	8	DIC_GENERAL_PURPOSE_H
General purpose I	7	DIC_GENERAL_PURPOSE_I
General purpose J	6	DIC_GENERAL_PURPOSE_J
Quick stop	5	DIC_QUICK_STOP
Device enable	4	DIC_DRIVE_ENABLE
Position marker	3	DIC_POSITION_MARKER
Home switch	2	DIC_HOME_SWITCH
Positive limit switch	1	DIC_POSITIVE_LIMIT_SWITCH
Negative limit switch	0	DIC_NEGATIVE_LIMIT_SWITCH

Table 4-14 Digital input configuration

### 4.2.5.2 VCS\_DigitalOutputConfiguration

**FUNCTION**

BOOL VCS\_DigitalOutputConfiguration(HANDLE KeyHandle, WORD NodeId, WORD DigitalOutputNb, WORD Configuration, BOOL State, BOOL Mask, BOOL Polarity, DWORD\* pErrorCode)

**DESCRIPTION**

VCS\_DigitalOutputConfiguration sets parameter for one digital output.

**PARAMETERS**

KeyHandle	HANDLE	Handle for port access
NodeId	WORD	Node-ID of the addressed device
DigitalOutputNb	WORD	Number of digital output (object subindex)
Configuration	WORD	Configures the functionality assigned to the digital output (bit number) (→ Table 4-15)
State	BOOL	State of digital output
Mask	BOOL	1: Functionality state will be set 0: not set (not supported for EPOS4)
Polarity	BOOL	1: Low active 0: High active

**RETURN PARAMETERS**

pErrorCode	DWORD*	Error information on the executed function
------------	--------	--

<b>Return Value</b>	BOOL	Nonzero if successful; otherwise "0"
---------------------	------	--------------------------------------

Description	Value	Name
None	255	DOC_NO_FUNCTIONALITY
General purpose A	15	DIC_GENERAL_PURPOSE_A
General purpose B	14	DIC_GENERAL_PURPOSE_B
General purpose C	13	DIC_GENERAL_PURPOSE_C
General purpose D	12	DIC_GENERAL_PURPOSE_D
General purpose E	11	DIC_GENERAL_PURPOSE_E
Position compare	1	DOC_POSITION_COMPARE
Ready / Fault	0	DOC_READY_FAULT

Table 4-15 Digital output configuration

**4.2.5.3 VCS\_AnalogInputConfiguration**

**FUNCTION**

BOOL VCS\_AnalogInputConfiguration(HANDLE KeyHandle, WORD NodeId, WORD AnalogInputNb, WORD Configuration, BOOL ExecutionMask, DWORD\* pErrorCode)

**DESCRIPTION**

VCS\_AnalogInputConfiguration sets the configuration parameter for one analog input.

**PARAMETERS**

KeyHandle	HANDLE	Handle for port access
NodeId	WORD	Node-ID of the addressed device
AnalogInputNb	WORD	Number of analog input (object subindex)
Configuration	WORD	Configures the functionality assigned to the analog input (bit number) (→Table 4-16)
ExecutionMask	BOOL	1: Register will be modified

**RETURN PARAMETERS**

pErrorCode	DWORD*	Error information on the executed function
------------	--------	--

<b>Return Value</b>	BOOL	Nonzero if successful; otherwise "0"
---------------------	------	--------------------------------------

Description	Value	Name
Analog current setpoint	0	AIC_ANALOG_CURRENT_SETPOINT
Analog velocity setpoint	1	AIC_ANALOG_VELOCITY_SETPOINT
Analog position setpoint	2	AIC_ANALOG_POSITION_SETPOINT
General purpose H	8	AIC_GENERAL_PURPOSE_H
General purpose G	9	AIC_GENERAL_PURPOSE_G
General purpose F	10	AIC_GENERAL_PURPOSE_F
General purpose E	11	AIC_GENERAL_PURPOSE_E
General purpose D	12	AIC_GENERAL_PURPOSE_D
General purpose C	13	AIC_GENERAL_PURPOSE_C
General purpose B	14	AIC_GENERAL_PURPOSE_B
General purpose A	15	AIC_GENERAL_PURPOSE_A

Table 4-16 Analog input configuration

### 4.2.5.4 VCS\_AnalogOutputConfiguration

**FUNCTION**

BOOL VCS\_AnalogOutputConfiguration(HANDLE KeyHandle, WORD NodeId, WORD AnalogOutputNb, WORD Configuration, DWORD\* pErrorCode)

**DESCRIPTION**

VCS\_AnalogOutputConfiguration sets the configuration parameter for one analog output.

**PARAMETERS**

KeyHandle	HANDLE	Handle for port access
NodeId	WORD	Node-ID of the addressed device
AnalogOutputNb	WORD	Number of analog output
Configuration	WORD	Configures the functionality assigned to the analog input (→Table 4-17)

**RETURN PARAMETERS**

pErrorCode	DWORD*	Error information on the executed function
------------	--------	--

<b>Return Value</b>	BOOL	Nonzero if successful; otherwise "0"
---------------------	------	--------------------------------------

Description	Value	Name
General purpose A	0	AOC_GENERAL_PURPOSE_A
General purpose B	1	AOC_GENERAL_PURPOSE_B

Table 4-17 Analog output configuration



#### 4.2.6 Units

##### 4.2.6.1 VCS\_SetVelocityUnits

**FUNCTION**

BOOL VCS\_SetVelocityUnits(HANDLE KeyHandle, WORD NodeId, BYTE VelDimension, char VelNotation, DWORD\* pErrorCode)

**DESCRIPTION**

VCS\_SetVelocityUnits writes velocity unit parameters.

**PARAMETERS**

KeyHandle	HANDLE	Handle for port access
NodeId	WORD	Node-ID of the addressed device
VelDimension	BYTE	Velocity dimension index VD_RPM = 0xA4
VelNotation	char	Velocity notation index (→ Table 4-18)

**RETURN PARAMETERS**

pErrorCode	DWORD*	Error information on the executed function
------------	--------	--

<b>Return Value</b>	BOOL	Nonzero if successful; otherwise "0"
---------------------	------	--------------------------------------

Description	Value	Name
Standard	0	VN_STANDARD
Deci (10 <sup>-1</sup> )	-1	VN_DECI
Centi (10 <sup>-2</sup> )	-2	VN_CENTI
Milli (10 <sup>-3</sup> )	-3	VN_MILLI

Table 4-18 Velocity notation index

##### 4.2.6.2 VCS\_GetVelocityUnits

**FUNCTION**

BOOL VCS\_GetVelocityUnits(HANDLE KeyHandle, WORD NodeId, BYTE\* pVelDimension, char\* pVelNotation, DWORD\* pErrorCode)

**DESCRIPTION**

VCS\_GetVelocityUnits reads velocity unit parameters.

**PARAMETERS**

KeyHandle	HANDLE	Handle for port access
NodeId	WORD	Node-ID of the addressed device

**RETURN PARAMETERS**

pVelDimension	BYTE*	Velocity dimension index VD_RPM = 0xA4
pVelNotation	char*	Velocity notation index (→ Table 4-18)
pErrorCode	DWORD*	Error information on the executed function

<b>Return Value</b>	BOOL	Nonzero if successful; otherwise "0"
---------------------	------	--------------------------------------

*••page intentionally left blank••*

## 5 Operation Functions



### Availability of functions

The availability of certain functions depends on the used hardware. For an overview → “Appendix A — Hardware vs. Functions” on page 11-161.

### 5.1 Operation Mode

#### 5.1.1 VCS\_SetOperationMode

##### FUNCTION

BOOL VCS\_SetOperationMode(HANDLE KeyHandle, WORD NodeId, \_\_int8 Mode, DWORD\* pErrorCode)

##### DESCRIPTION

VCS\_SetOperationMode sets the operation mode. Modes marked with a triple asterisk (\*\*\*) are automatically mapped to EPOS4-compatible firmware operation modes as to → Table 5-20.

##### PARAMETERS

KeyHandle	HANDLE	Handle for port access
NodeId	WORD	Node-ID of the addressed device
Mode	__int8	Operation mode (→ Table 5-19)

##### RETURN PARAMETERS

pErrorCode	DWORD*	Error information on the executed function
------------	--------	--

<b>Return Value</b>	BOOL	Nonzero if successful; otherwise “0”
---------------------	------	--------------------------------------

Description	Value	Name
Profile Position Mode (PPM)	1	OMD_PROFILE_POSITION_MODE
Profile Velocity Mode (PVM)	3	OMD_PROFILE_VELOCITY_MODE
Homing Mode (HM)	6	OMD_HOMING_MODE
Interpolated Position Mode (IPM)	7	OMD_INTERPOLATED_POSITION_MODE
Position Mode (PM, CSP)***	-1	OMD_POSITION_MODE
Velocity Mode (VM, CSV)***	-2	OMD_VELOCITY_MODE
Current Mode (CM, CST)***	-3	OMD_CURRENT_MODE
Master Encoder Mode	-5	OMD_MASTER_ENCODER_MODE
Step Direction Mode	-6	OMD_STEP_DIRECTION_MODE

Table 5-19 Operation modes

Continued on next page.

Mapped from		Mapped to	
Name	Value	Name	Value
Position Mode (PM)	-1	Cyclic Synchronous Position Mode (CSP)	8
Velocity Mode (VM)	-2	Cyclic Synchronous Velocity Mode (CSV)	9
Current Mode (CM)	-3	Cyclic Synchronous Current Mode (CST)	10

Table 5-20 Mapped operation modes

### 5.1.2 VCS\_GetOperationMode

**FUNCTION**

BOOL VCS\_GetOperationMode(HANDLE KeyHandle, WORD NodeId, \_\_int8\* pMode, DWORD\* pErrorCode)

**DESCRIPTION**

VCS\_GetOperationMode returns the activated operation mode.

**PARAMETERS**

KeyHandle	HANDLE	Handle for port access
NodeId	WORD	Node-ID of the addressed device

**RETURN PARAMETERS**

pMode	__int8*	Operation mode (→ Table 5-19)
pErrorCode	DWORD*	Error information on the executed function

<b>Return Value</b>	BOOL	Nonzero if successful; otherwise "0"
---------------------	------	--------------------------------------

## 5.2 State Machine

For detailed information on the state machine → separate document «Firmware Specification».

### 5.2.1 VCS\_ResetDevice

**FUNCTION**

BOOL VCS\_ResetDevice(HANDLE KeyHandle, WORD NodeId, DWORD\* pErrorCode)

**DESCRIPTION**

VCS\_ResetDevice is used to send the NMT service “Reset Node”. Command is without acknowledge.

**PARAMETERS**

KeyHandle	HANDLE	Handle for port access
NodeId	WORD	Node-ID of the addressed device

**RETURN PARAMETERS**

pErrorCode	DWORD*	Error information on the executed function
------------	--------	--

<b>Return Value</b>	BOOL	Nonzero if successful; otherwise “0”
---------------------	------	--------------------------------------

### 5.2.2 VCS\_SetState

**FUNCTION**

BOOL VCS\_SetState(HANDLE KeyHandle, WORD NodeId, WORD State, DWORD\* pErrorCode)

**DESCRIPTION**

VCS\_SetState reads the actual state machine state.

**PARAMETERS**

KeyHandle	HANDLE	Handle for port access
NodeId	WORD	Node-ID of the addressed device
State	WORD	Value of state machine (→ Table 5-21)

**RETURN PARAMETERS**

pErrorCode	DWORD*	Error information on the executed function
------------	--------	--

<b>Return Value</b>	BOOL	Nonzero if successful; otherwise “0”
---------------------	------	--------------------------------------

Description	Value	Name
Get/Set Disable State	0x0000	ST_DISABLED
Get/Set Enable State	0x0001	ST_ENABLED
Get/Set Quickstop State	0x0002	ST_QUICKSTOP
Get Fault State	0x0003	ST_FAULT

Table 5-21 State modes

### 5.2.3 VCS\_SetEnableState

**FUNCTION**

BOOL VCS\_SetEnableState(HANDLE KeyHandle, WORD NodeId, DWORD\* pErrorCode)

**DESCRIPTION**

VCS\_SetEnableState changes the device state to “enable”.

**PARAMETERS**

KeyHandle	HANDLE	Handle for port access
NodeId	WORD	Node-ID of the addressed device

**RETURN PARAMETERS**

pErrorCode	DWORD*	Error information on the executed function
------------	--------	--

<b>Return Value</b>	BOOL	Nonzero if successful; otherwise “0”
---------------------	------	--------------------------------------

### 5.2.4 VCS\_SetDisableState

**FUNCTION**

BOOL VCS\_SetDisableState(HANDLE KeyHandle, WORD NodeId, DWORD\* pErrorCode)

**DESCRIPTION**

VCS\_SetDisableState changes the device state to “disable”.

**PARAMETERS**

KeyHandle	HANDLE	Handle for port access
NodeId	WORD	Node-ID of the addressed device

**RETURN PARAMETERS**

pErrorCode	DWORD*	Error information on the executed function
------------	--------	--

<b>Return Value</b>	BOOL	Nonzero if successful; otherwise “0”
---------------------	------	--------------------------------------

### 5.2.5 VCS\_SetQuickStopState

**FUNCTION**

BOOL VCS\_SetQuickStopState(HANDLE KeyHandle, WORD NodeId, DWORD\* pErrorCode)

**DESCRIPTION**

VCS\_SetQuickStopState changes the device state to “quick stop”.

**PARAMETERS**

KeyHandle	HANDLE	Handle for port access
NodeId	WORD	Node-ID of the addressed device

**RETURN PARAMETERS**

pErrorCode	DWORD*	Error information on the executed function
------------	--------	--

<b>Return Value</b>	BOOL	Nonzero if successful; otherwise “0”
---------------------	------	--------------------------------------

**5.2.6 VCS\_ClearFault****FUNCTION**

BOOL VCS\_ClearFault(HANDLE KeyHandle, WORD NodeId, DWORD\* pErrorCode)

**DESCRIPTION**

VCS\_ClearFault changes the device state from "fault" to "disable".

**PARAMETERS**

KeyHandle	HANDLE	Handle for port access
NodeId	WORD	Node-ID of the addressed device

**RETURN PARAMETERS**

pErrorCode	DWORD*	Error information on the executed function
------------	--------	--

<b>Return Value</b>	BOOL	Nonzero if successful; otherwise "0"
---------------------	------	--------------------------------------

**5.2.7 VCS\_GetState****FUNCTION**

BOOL VCS\_GetState(HANDLE KeyHandle, WORD NodeId, WORD\* pState, DWORD\* pErrorCode)

**DESCRIPTION**

VCS\_GetState reads the new state of the state machine.

**PARAMETERS**

KeyHandle	HANDLE	Handle for port access
NodeId	WORD	Node-ID of the addressed device

**RETURN PARAMETERS**

pState	WORD*	Statusword value (→ Table 5-21)
pErrorCode	DWORD*	Error information on the executed function

<b>Return Value</b>	BOOL	Nonzero if successful; otherwise "0"
---------------------	------	--------------------------------------

## 5.2.8 VCS\_GetEnableState

**FUNCTION**

BOOL VCS\_GetEnableState(HANDLE KeyHandle, WORD NodeId, BOOL\* pIsEnabled, DWORD\* pErrorCode)

**DESCRIPTION**

VCS\_GetEnableState checks if the device is enabled.

**PARAMETERS**

KeyHandle	HANDLE	Handle for port access
NodeId	WORD	Node-ID of the addressed device

**RETURN PARAMETERS**

pIsEnabled	BOOL*	1: Device enabled 0: Device not enabled
pErrorCode	DWORD*	Error information on the executed function

<b>Return Value</b>	BOOL	Nonzero if successful; otherwise "0"
---------------------	------	--------------------------------------

## 5.2.9 VCS\_GetDisableState

**FUNCTION**

BOOL VCS\_GetDisableState(HANDLE KeyHandle, WORD NodeId, BOOL\* pIsDisabled, DWORD\* pErrorCode)

**DESCRIPTION**

VCS\_GetDisableState checks if the device is disabled.

**PARAMETERS**

KeyHandle	HANDLE	Handle for port access
NodeId	WORD	Node-ID of the addressed device

**RETURN PARAMETERS**

pIsDisabled	BOOL*	1: Device disabled 0: Device not disabled
pErrorCode	DWORD*	Error information on the executed function

<b>Return Value</b>	BOOL	Nonzero if successful; otherwise "0"
---------------------	------	--------------------------------------



**5.2.10 VCS\_GetQuickStopState****FUNCTION**

BOOL VCS\_GetQuickStopState(HANDLE KeyHandle, WORD NodeId, BOOL\* plsQuickStopped, DWORD\* pErrorCode)

**DESCRIPTION**

VCS\_GetQuickStopState returns the device state quick stop.

**PARAMETERS**

KeyHandle	HANDLE	Handle for port access
NodeId	WORD	Node-ID of the addressed device

**RETURN PARAMETERS**

plsQuickStopped	BOOL*	1: Device is in quick stop state 0: Device is not in quick stop state
pErrorCode	DWORD*	Error information on the executed function

<b>Return Value</b>	BOOL	Nonzero if successful; otherwise "0"
---------------------	------	--------------------------------------

**5.2.11 VCS\_GetFaultState****FUNCTION**

BOOL VCS\_GetFaultState(HANDLE KeyHandle, WORD NodeId, BOOL\* plsInFault, DWORD\* pErrorCode)

**DESCRIPTION**

VCS\_GetFaultState returns the device state fault. Get error information if the device is in fault state (→ "Error Handling" on page 5-66).

**PARAMETERS**

KeyHandle	HANDLE	Handle for port access
NodeId	WORD	Node-ID of the addressed device

**RETURN PARAMETERS**

plsInFault	BOOL*	1: Device is in fault state 0: Device is not in fault state
pErrorCode	DWORD*	Error information on the executed function

<b>Return Value</b>	BOOL	Nonzero if successful; otherwise "0"
---------------------	------	--------------------------------------

## 5.3 Error Handling

### 5.3.1 VCS\_GetNbOfDeviceError

**FUNCTION**

BOOL VCS\_GetNbOfDeviceError(HANDLE KeyHandle, WORD NodeId, BYTE\* pNbDeviceError, DWORD\* pErrorCode)

**DESCRIPTION**

VCS\_GetNbOfDeviceError returns the number of actual errors that are recorded.

**PARAMETERS**

KeyHandle	HANDLE	Handle for port access
NodeId	WORD	Node-ID of the addressed device

**RETURN PARAMETERS**

pNbDeviceError	BYTE*	Number of occurred device errors
pErrorCode	DWORD*	Error information on the executed function

<b>Return Value</b>	BOOL	Nonzero if successful; otherwise "0"
---------------------	------	--------------------------------------

**PROGRAMMING EXAMPLE**

```
HANDLE keyHandle = 0;
WORD nodeId = 1;
DWORD errorCode = 0;
BOOL result = FALSE;

//...
result = VCS_GetNbOfDeviceError(keyHandle, nodeId, &nbOfDeviceError, &errorCode);
//...
```

Figure 5-18 VCS\_GetNbOfDeviceError (programming example)

**5.3.2 VCS\_GetDeviceErrorCode****FUNCTION**

BOOL VCS\_GetDeviceErrorCode(HANDLE KeyHandle, WORD NodeId, BYTE ErrorNumber, DWORD\* pDeviceErrorCode, DWORD\* pErrorCode)

**DESCRIPTION**

VCS\_GetDeviceErrorCode returns the error code of the selected error number.

**PARAMETERS**

KeyHandle	HANDLE	Handle for port access
NodeId	WORD	Node-ID of the addressed device
ErrorNumber	BYTE	Number (object subindex) of device error ( $\geq 1$ )

**RETURN PARAMETERS**

pDeviceErrorCode	DWORD*	Actual error code from error history
pErrorCode	DWORD*	Error information on the executed function

<b>Return Value</b>	BOOL	Nonzero if successful; otherwise "0"
---------------------	------	--------------------------------------

**PROGRAMMING EXAMPLE**

```

HANDLE keyHandle = 0;
WORD nodeId = 1;
BYTE nbOfDeviceError;
DWORD deviceErrorCode = 0;
DWORD errorCode = 0;

//...
if(VCS_GetNbOfDeviceError(keyHandle, nodeId, &nbOfDeviceError, &errorCode)
{
    for(BYTE errorNumber = 1, errorNumber <= nbOfDeviceError; errorNumber++)
    {
        if(!VCS_GetDeviceErrorCode(keyHandle, nodeId, errorNumber, &deviceErrorCode, &errorCode)
        {
            break;
        }
    }
}
//...

```

Figure 5-19 VCS\_GetDeviceErrorCode (programming example)

## 5.4 Motion Info

### 5.4.1 VCS\_GetMovementState

**FUNCTION**

BOOL VCS\_GetMovementState(HANDLE KeyHandle, WORD NodeId, BOOL\* pTargetReached, DWORD\* pErrorCode)

**DESCRIPTION**

VCS\_GetMovementState checks if the drive has reached target.

**PARAMETERS**

KeyHandle	HANDLE	Handle for port access
NodeId	WORD	Node-ID of the addressed device

**RETURN PARAMETERS**

pTargetReached	BOOL*	Drive has reached the target. Function reads actual state of bit 10 from the statusword.
pErrorCode	DWORD*	Error information on the executed function

<b>Return Value</b>	BOOL	Nonzero if successful; otherwise "0"
---------------------	------	--------------------------------------

### 5.4.2 VCS\_GetPositionIs

**FUNCTION**

BOOL VCS\_GetPositionIs(HANDLE KeyHandle, WORD NodeId, long\* pPositionIs, DWORD\* pErrorCode)

**DESCRIPTION**

VCS\_GetPositionIs returns the position actual value.

**PARAMETERS**

KeyHandle	HANDLE	Handle for port access
NodeId	WORD	Node-ID of the addressed device

**RETURN PARAMETERS**

pPositionIs	long*	Position actual value
pErrorCode	DWORD*	Error information on the executed function

<b>Return Value</b>	BOOL	Nonzero if successful; otherwise "0"
---------------------	------	--------------------------------------

**5.4.3 VCS\_GetVelocityIs****FUNCTION**

BOOL VCS\_GetVelocityIs(HANDLE KeyHandle, WORD NodeId, long\* pVelocityIs, DWORD\* pErrorCode)

**DESCRIPTION**

VCS\_GetVelocityIs reads the velocity actual value. The velocity is interpreted according to the currently configured velocity unit.

**PARAMETERS**

KeyHandle	HANDLE	Handle for port access
NodeId	WORD	Node-ID of the addressed device

**RETURN PARAMETERS**

pVelocityIs	long*	Velocity actual value
pErrorCode	DWORD*	Error information on the executed function

<b>Return Value</b>	BOOL	Nonzero if successful; otherwise "0"
---------------------	------	--------------------------------------

**5.4.4 VCS\_GetVelocityIsAveraged****FUNCTION**

BOOL VCS\_GetVelocityIsAveraged(HANDLE KeyHandle, WORD NodeId, long\* pVelocityIsAveraged, DWORD\* pErrorCode)

**DESCRIPTION**

VCS\_GetVelocityIsAveraged reads the velocity actual averaged value. The velocity is interpreted according to the currently configured velocity unit.

**PARAMETERS**

KeyHandle	HANDLE	Handle for port access
NodeId	WORD	Node-ID of the addressed device

**RETURN PARAMETERS**

pVelocityIsAveraged	long*	Velocity actual value averaged
pErrorCode	DWORD*	Error information on the executed function

<b>Return Value</b>	BOOL	Nonzero if successful; otherwise "0"
---------------------	------	--------------------------------------

### 5.4.5 VCS\_GetCurrentIs

**FUNCTION**

BOOL VCS\_GetCurrentIs(HANDLE KeyHandle, WORD NodeId, short\* pCurrentIs, DWORD\* pErrorCode)

**DESCRIPTION**

VCS\_GetCurrentIs returns the current actual value.

**PARAMETERS**

KeyHandle	HANDLE	Handle for port access
NodeId	WORD	Node-ID of the addressed device

**RETURN PARAMETERS**

pCurrentIs	short*	Current actual value
pErrorCode	DWORD*	Error information on the executed function

<b>Return Value</b>	BOOL	Nonzero if successful; otherwise "0"
---------------------	------	--------------------------------------

### 5.4.6 VCS\_GetCurrentIsAveraged

**FUNCTION**

BOOL VCS\_GetCurrentIsAveraged(HANDLE KeyHandle, WORD NodeId, short\* pCurrentIsAveraged, DWORD\* pErrorCode)

**DESCRIPTION**

VCS\_GetCurrentIsAveraged returns the current actual averaged value.

**PARAMETERS**

KeyHandle	HANDLE	Handle for port access
NodeId	WORD	Node-ID of the addressed device

**RETURN PARAMETERS**

pCurrentIsAveraged	short*	Current actual value averaged
pErrorCode	DWORD*	Error information on the executed function

<b>Return Value</b>	BOOL	Nonzero if successful; otherwise "0"
---------------------	------	--------------------------------------

**5.4.7 VCS\_WaitForTargetReached****FUNCTION**

BOOL VCS\_WaitForTargetReached(HANDLE KeyHandle, WORD NodeId, DWORD Timeout, DWORD\* pErrorCode)

**DESCRIPTION**

VCS\_WaitForTargetReached waits until the state is changed to target reached or until the time is up.

**PARAMETERS**

KeyHandle	HANDLE	Handle for port access
NodeId	WORD	Node-ID of the addressed device
Timeout	DWORD	Max. wait time [ms] until target reached

**RETURN PARAMETERS**

pErrorCode	DWORD*	Error information on the executed function
------------	--------	--

<b>Return Value</b>	BOOL	Nonzero if successful; otherwise "0"
---------------------	------	--------------------------------------

## 5.5 Profile Position Mode (PPM)

### 5.5.1 VCS\_ActivateProfilePositionMode

**FUNCTION**

BOOL VCS\_ActivateProfilePositionMode(HANDLE KeyHandle, WORD NodeId, DWORD\* pErrorCode)

**DESCRIPTION**

VCS\_ActivateProfilePositionMode changes the operational mode to “profile position mode”.

**PARAMETERS**

KeyHandle	HANDLE	Handle for port access
NodeId	WORD	Node-ID of the addressed device

**RETURN PARAMETERS**

pErrorCode	DWORD*	Error information on the executed function
------------	--------	--

<b>Return Value</b>	BOOL	Nonzero if successful; otherwise “0”
---------------------	------	--------------------------------------

### 5.5.2 VCS\_SetPositionProfile

**FUNCTION**

BOOL VCS\_SetPositionProfile(HANDLE KeyHandle, WORD NodeId, DWORD ProfileVelocity, DWORD ProfileAcceleration, DWORD ProfileDeceleration, DWORD\* pErrorCode)

**DESCRIPTION**

VCS\_SetPositionProfile sets the position profile parameters.

**PARAMETERS**

KeyHandle	HANDLE	Handle for port access
NodeId	WORD	Node-ID of the addressed device
ProfileVelocity	DWORD	Position profile velocity. Given in velocity units.
ProfileAcceleration	DWORD	Position profile acceleration
ProfileDeceleration	DWORD	Position profile deceleration

**RETURN PARAMETERS**

pErrorCode	DWORD*	Error information on the executed function
------------	--------	--

<b>Return Value</b>	BOOL	Nonzero if successful; otherwise “0”
---------------------	------	--------------------------------------



## 5.5.3 VCS\_GetPositionProfile

### FUNCTION

BOOL VCS\_GetPositionProfile(HANDLE KeyHandle, WORD NodeId, DWORD\* pProfileVelocity, DWORD\* pProfileAcceleration, DWORD\* pProfileDeceleration, DWORD\* pErrorCode)

### DESCRIPTION

VCS\_GetPositionProfile returns the position profile parameters.

### PARAMETERS

KeyHandle	HANDLE	Handle for port access
NodeId	WORD	Node-ID of the addressed device

### RETURN PARAMETERS

pProfileVelocity	DWORD*	Position profile velocity. Given in velocity units.
pProfileAcceleration	DWORD*	Position profile acceleration
pProfileDeceleration	DWORD*	Position profile deceleration
pErrorCode	DWORD*	Error information on the executed function

<b>Return Value</b>	BOOL	Nonzero if successful; otherwise "0"
---------------------	------	--------------------------------------

## 5.5.4 VCS\_MoveToPosition

### FUNCTION

BOOL VCS\_MoveToPosition(HANDLE KeyHandle, WORD NodeId, long TargetPosition, BOOL Absolute, BOOL Immediately, DWORD\* pErrorCode)

### DESCRIPTION

VCS\_MoveToPosition starts movement with position profile to target position.

### PARAMETERS

KeyHandle	HANDLE	Handle for port access
NodeId	WORD	Node-ID of the addressed device
TargetPosition	long	Target position
Absolute	BOOL	TRUE starts an absolute FALSE a relative movement
Immediately	BOOL	TRUE starts immediately FALSE waits to end of last positioning

### RETURN PARAMETERS

pErrorCode	DWORD*	Error information on the executed function
------------	--------	--

<b>Return Value</b>	BOOL	Nonzero if successful; otherwise "0"
---------------------	------	--------------------------------------

### 5.5.5 VCS\_GetTargetPosition

**FUNCTION**

BOOL VCS\_GetTargetPosition(HANDLE KeyHandle, WORD NodeId, long\* pTargetPosition, DWORD\* pErrorCode)

**DESCRIPTION**

VCS\_GetTargetPosition returns the profile position mode target value.

**PARAMETERS**

KeyHandle	HANDLE	Handle for port access
NodeId	WORD	Node-ID of the addressed device

**RETURN PARAMETERS**

pTargetPosition	long*	Target position
pErrorCode	DWORD*	Error information on the executed function

<b>Return Value</b>	BOOL	Nonzero if successful; otherwise "0"
---------------------	------	--------------------------------------

### 5.5.6 VCS\_HaltPositionMovement

**FUNCTION**

BOOL VCS\_HaltPositionMovement(HANDLE KeyHandle, WORD NodeId, DWORD\* pErrorCode)

**DESCRIPTION**

VCS\_HaltPositionMovement stops the movement with profile deceleration.

**PARAMETERS**

KeyHandle	HANDLE	Handle for port access
NodeId	WORD	Node-ID of the addressed device

**RETURN PARAMETERS**

pErrorCode	DWORD*	Error information on the executed function
------------	--------	--

<b>Return Value</b>	BOOL	Nonzero if successful; otherwise "0"
---------------------	------	--------------------------------------

**5.5.7 Advanced Functions****5.5.7.1 VCS\_EnablePositionWindow****FUNCTION**

BOOL VCS\_EnablePositionWindow(HANDLE KeyHandle, WORD NodeId, DWORD PositionWindow, WORD PositionWindowTime, DWORD\* pErrorCode)

**DESCRIPTION**

VCS\_EnablePositionWindow activates the position window.

**PARAMETERS**

KeyHandle	HANDLE	Handle for port access
NodeId	WORD	Node-ID of the addressed device
PositionWindow	DWORD	Position window value
PositionWindowTime	WORD	Position window time value

**RETURN PARAMETERS**

pErrorCode	DWORD*	Error information on the executed function
------------	--------	--

<b>Return Value</b>	BOOL	Nonzero if successful; otherwise "0"
---------------------	------	--------------------------------------

**5.5.7.2 VCS\_DisablePositionWindow****FUNCTION**

BOOL VCS\_DisablePositionWindow(HANDLE KeyHandle, WORD NodeId, DWORD\* pErrorCode)

**DESCRIPTION**

VCS\_DisablePositionWindow deactivates the position window.

**PARAMETERS**

KeyHandle	HANDLE	Handle for port access
NodeId	WORD	Node-ID of the addressed device

**RETURN PARAMETERS**

pErrorCode	DWORD*	Error information on the executed function
------------	--------	--

<b>Return Value</b>	BOOL	Nonzero if successful; otherwise "0"
---------------------	------	--------------------------------------

## 5.6 Profile Velocity Mode (PVM)

### 5.6.1 VCS\_ActivateProfileVelocityMode

**FUNCTION**

BOOL VCS\_ActivateProfileVelocityMode(HANDLE KeyHandle, WORD NodeId, DWORD\* pErrorCode)

**DESCRIPTION**

VCS\_ActivateProfileVelocityMode changes the operational mode to "profile velocity mode".

**PARAMETERS**

KeyHandle	HANDLE	Handle for port access
NodeId	WORD	Node-ID of the addressed device

**RETURN PARAMETERS**

pErrorCode	DWORD*	Error information on the executed function
------------	--------	--

<b>Return Value</b>	BOOL	Nonzero if successful; otherwise "0"
---------------------	------	--------------------------------------

### 5.6.2 VCS\_SetVelocityProfile

**FUNCTION**

BOOL VCS\_SetVelocityProfile(HANDLE KeyHandle, WORD NodeId, DWORD ProfileAcceleration, DWORD ProfileDeceleration, DWORD\* pErrorCode)

**DESCRIPTION**

VCS\_SetVelocityProfile sets the velocity profile parameters.

**PARAMETERS**

KeyHandle	HANDLE	Handle for port access
NodeId	WORD	Node-ID of the addressed device
ProfileAcceleration	DWORD	Velocity profile acceleration
ProfileDeceleration	DWORD	Velocity profile deceleration

**RETURN PARAMETERS**

pErrorCode	DWORD*	Error information on the executed function
------------	--------	--

<b>Return Value</b>	BOOL	Nonzero if successful; otherwise "0"
---------------------	------	--------------------------------------

### 5.6.3 VCS\_GetVelocityProfile

**FUNCTION**

BOOL VCS\_GetVelocityProfile(HANDLE KeyHandle, WORD NodeId, DWORD\* pProfileAcceleration, DWORD\* pProfileDeceleration, DWORD\* pErrorCode)

**DESCRIPTION**

VCS\_GetVelocityProfile returns the velocity profile parameters.

**PARAMETERS**

KeyHandle	HANDLE	Handle for port access
NodeId	WORD	Node-ID of the addressed device

**RETURN PARAMETERS**

pProfileAcceleration	DWORD*	Velocity profile acceleration
pProfileDeceleration	DWORD*	Velocity profile deceleration
pErrorCode	DWORD*	Error information on the executed function

<b>Return Value</b>	BOOL	Nonzero if successful; otherwise "0"
---------------------	------	--------------------------------------

### 5.6.4 VCS\_MoveWithVelocity

**FUNCTION**

BOOL VCS\_MoveWithVelocity(HANDLE KeyHandle, WORD NodeId, long TargetVelocity, DWORD\* pErrorCode)

**DESCRIPTION**

VCS\_MoveWithVelocity starts the movement with velocity profile to target velocity. The velocity is interpreted according to the currently configured velocity unit.

**PARAMETERS**

KeyHandle	HANDLE	Handle for port access
NodeId	WORD	Node-ID of the addressed device
TargetVelocity	long	Target velocity

**RETURN PARAMETERS**

pErrorCode	DWORD*	Error information on the executed function
------------	--------	--

<b>Return Value</b>	BOOL	Nonzero if successful; otherwise "0"
---------------------	------	--------------------------------------

## 5.6.5 VCS\_GetTargetVelocity

**FUNCTION**

BOOL VCS\_GetTargetVelocity(HANDLE KeyHandle, WORD NodeId, long\* pTargetVelocity, DWORD\* pErrorCode)

**DESCRIPTION**

VCS\_GetTargetVelocity returns the profile velocity mode target value. The velocity is interpreted according to the currently configured velocity unit.

**PARAMETERS**

KeyHandle	HANDLE	Handle for port access
NodeId	WORD	Node-ID of the addressed device

**RETURN PARAMETERS**

pTargetVelocity	long*	Target velocity
pErrorCode	DWORD*	Error information on the executed function

<b>Return Value</b>	BOOL	Nonzero if successful; otherwise "0"
---------------------	------	--------------------------------------

## 5.6.6 VCS\_HaltVelocityMovement

**FUNCTION**

BOOL VCS\_HaltVelocityMovement(HANDLE KeyHandle, WORD NodeId, DWORD\* pErrorCode)

**DESCRIPTION**

VCS\_HaltVelocityMovement stops the movement with profile deceleration.

**PARAMETERS**

KeyHandle	HANDLE	Handle for port access
NodeId	WORD	Node-ID of the addressed device

**RETURN PARAMETERS**

pErrorCode	DWORD*	Error information on the executed function
------------	--------	--

<b>Return Value</b>	BOOL	Nonzero if successful; otherwise "0"
---------------------	------	--------------------------------------

## 5.6.7 Advanced Functions

### 5.6.7.1 VCS\_EnableVelocityWindow

**FUNCTION**

BOOL VCS\_EnableVelocityWindow(HANDLE KeyHandle, WORD NodeId, DWORD VelocityWindow, WORD VelocityWindowTime, DWORD\* pErrorCode)

**DESCRIPTION**

VCS\_EnableVelocityWindow activates the velocity window.

**PARAMETERS**

KeyHandle	HANDLE	Handle for port access
NodeId	WORD	Node-ID of the addressed device
VelocityWindow	DWORD	Velocity window value. Given in velocity units.
VelocityWindowTime	WORD	Velocity window time value

**RETURN PARAMETERS**

pErrorCode	DWORD*	Error information on the executed function
------------	--------	--

<b>Return Value</b>	BOOL	Nonzero if successful; otherwise "0"
---------------------	------	--------------------------------------

### 5.6.7.2 VCS\_DisableVelocityWindow

**FUNCTION**

BOOL VCS\_DisableVelocityWindow(HANDLE KeyHandle, WORD NodeId, DWORD\* pErrorCode)

**DESCRIPTION**

VCS\_DisableVelocityWindow deactivates the velocity window.

**PARAMETERS**

KeyHandle	HANDLE	Handle for port access
NodeId	WORD	Node-ID of the addressed device

**RETURN PARAMETERS**

pErrorCode	DWORD*	Error information on the executed function
------------	--------	--

<b>Return Value</b>	BOOL	Nonzero if successful; otherwise "0"
---------------------	------	--------------------------------------

## 5.7 Homing Mode (HM)

### 5.7.1 VCS\_ActivateHomingMode

**FUNCTION**

BOOL VCS\_ActivateHomingMode(HANDLE KeyHandle, WORD NodeId, DWORD\* pErrorCode)

**DESCRIPTION**

VCS\_ActivateHomingMode changes the operational mode to "homing mode".

**PARAMETERS**

KeyHandle	HANDLE	Handle for port access
NodeId	WORD	Node-ID of the addressed device

**RETURN PARAMETERS**

pErrorCode	DWORD*	Error information on the executed function
------------	--------	--

<b>Return Value</b>	BOOL	Nonzero if successful; otherwise "0"
---------------------	------	--------------------------------------

### 5.7.2 VCS\_SetHomingParameter

**FUNCTION**

BOOL VCS\_SetHomingParameter(HANDLE KeyHandle, WORD NodeId, DWORD HomingAcceleration, DWORD SpeedSwitch, DWORD SpeedIndex, long HomeOffset, WORD CurrentThreshold, long HomePosition, DWORD\* pErrorCode)

**DESCRIPTION**

VCS\_SetHomingParameter writes all homing parameters. The parameter units depend on (position, velocity, acceleration) notation index.

**PARAMETERS**

KeyHandle	HANDLE	Handle for port access
NodeId	WORD	Node-ID of the addressed device
HomingAcceleration	DWORD	Acceleration for homing profile
SpeedSwitch	DWORD	Speed during search for switch
SpeedIndex	DWORD	Speed during search for index signal
HomeOffset	long	Home offset after homing
CurrentThreshold	DWORD	Current threshold for homing methods -1, -2, -3, and -4
HomePosition	long	Used to assign the present position as homing position

**RETURN PARAMETERS**

pErrorCode	DWORD*	Error information on the executed function
------------	--------	--

<b>Return Value</b>	BOOL	Nonzero if successful; otherwise "0"
---------------------	------	--------------------------------------



**5.7.3 VCS\_GetHomingParameter****FUNCTION**

BOOL VCS\_GetHomingParameter(HANDLE KeyHandle, WORD NodeId, DWORD\* pHomingAcceleration, DWORD\* pSpeedSwitch, DWORD\* pSpeedIndex, long\* pHomeOffset, WORD\* pCurrentThreshold, long\* pHomePosition, DWORD\* pErrorCode)

**DESCRIPTION**

VCS\_GetHomingParameter reads all homing parameters. The parameter units depend on (position, velocity, acceleration) notation index.

**PARAMETERS**

KeyHandle	HANDLE	Handle for port access
NodeId	WORD	Node-ID of the addressed device

**RETURN PARAMETERS**

pHomingAcceleration	DWORD*	Acceleration for homing profile
pSpeedSwitch	DWORD*	Speed during search for switch
pSpeedIndex	DWORD*	Speed during search for index signal
pHomeOffset	long*	Home offset after homing
pCurrentThreshold	DWORD*	Current threshold for homing methods -1, -2, -3, and -4
pHomePosition	long*	Home position value
pErrorCode	DWORD*	Error information on the executed function

<b>Return Value</b>	BOOL	Nonzero if successful; otherwise "0"
---------------------	------	--------------------------------------

### 5.7.4 VCS\_FindHome

**FUNCTION**

BOOL VCS\_FindHome(HANDLE KeyHandle, WORD NodeId, \_\_int8 HomingMethod, DWORD\* pErrorCode)

**DESCRIPTION**

VCS\_FindHome and HomingMethod permit to find the system home (for example, a home switch).

**PARAMETERS**

KeyHandle	HANDLE	Handle for port access
NodeId	WORD	Node-ID of the addressed device
HomingMethod	__int8	Homing method (→ Table 5-22)

**RETURN PARAMETERS**

pErrorCode	DWORD*	Error information on the executed function
------------	--------	--

<b>Return Value</b>	BOOL	Nonzero if successful; otherwise "0"
---------------------	------	--------------------------------------

**HOMING METHODS**

Description	Method	Name
Actual Position	35	HM_ACTUAL_POSITION
Index Positive Speed	34	HM_INDEX_POSITIVE_SPEED
Index Negative Speed	33	HM_INDEX_NEGATIVE_SPEED
Home Switch Negative Speed	27	HM_HOME_SWITCH_NEGATIVE_SPEED
Home Switch Positive Speed	23	HM_HOME_SWITCH_POSITIVE_SPEED
Positive Limit Switch	18	HM_POSITIVE_LIMIT_SWITCH
Negative Limit Switch	17	HM_NEGATIVE_LIMIT_SWITCH
Home Switch Negative Speed & Index	11	HM_HOME_SWITCH_NEGATIVE_SPEED_AND_INDEX
Home Switch Positive Speed & Index	7	HM_HOME_SWITCH_POSITIVE_SPEED_AND_INDEX
Positive Limit Switch & Index	2	HM_POSITIVE_LIMIT_SWITCH_AND_INDEX
Negative Limit Switch & Index	1	HM_NEGATIVE_LIMIT_SWITCH_AND_INDEX
No homing operation required	0	–
Current Threshold Positive Speed & Index	-1	HM_CURRENT_THRESHOLD_NEGATIVE_SPEED_AND_INDEX
Current Threshold Negative Speed & Index	-2	HM_CURRENT_THRESHOLD_NEGATIVE_SPEED_AND_INDEX
Current Threshold Positive Speed	-3	HM_CURRENT_THRESHOLD_POSITIVE_SPEED
Current Threshold Negative Speed	-4	HM_CURRENT_THRESHOLD_NEGATIVE_SPEED

Table 5-22 Homing methods

**5.7.5 VCS\_StopHoming****FUNCTION**

BOOL VCS\_StopHoming(HANDLE KeyHandle, WORD NodeId, DWORD\* pErrorCode)

**DESCRIPTION**

VCS\_StopHoming interrupts homing.

**PARAMETERS**

KeyHandle	HANDLE	Handle for port access
NodeId	WORD	Node-ID of the addressed device

**RETURN PARAMETERS**

pErrorCode	DWORD*	Error information on the executed function
------------	--------	--

<b>Return Value</b>	BOOL	Nonzero if successful; otherwise "0"
---------------------	------	--------------------------------------

**5.7.6 VCS\_DefinePosition****FUNCTION**

BOOL VCS\_DefinePosition(HANDLE KeyHandle, WORD NodeId, long HomePosition, DWORD\* pErrorCode)

**DESCRIPTION**

VCS\_DefinePosition uses homing method 35 (Actual Position) to set a new home position.

**PARAMETERS**

KeyHandle	HANDLE	Handle for port access
NodeId	WORD	Node-ID of the addressed device
HomePosition	long	Used to assign the present position as homing position

**RETURN PARAMETERS**

pErrorCode	DWORD*	Error information on the executed function
------------	--------	--

<b>Return Value</b>	BOOL	Nonzero if successful; otherwise "0"
---------------------	------	--------------------------------------

### 5.7.7 VCS\_GetHomingState

**FUNCTION**

BOOL VCS\_GetHomingState(HANDLE KeyHandle, WORD NodeId, BOOL\* pHomingAttained, BOOL\* pHomingError, DWORD\* pErrorCode)

**DESCRIPTION**

VCS\_GetHomingState returns the states if the homing position is attained and if an homing error has occurred.

**PARAMETERS**

KeyHandle	HANDLE	Handle for port access
NodeId	WORD	Node-ID of the addressed device

**RETURN PARAMETERS**

pHomingAttained	BOOL*	0: Homing mode not yet completed 1: Homing mode successfully terminated
pHomingError	BOOL*	0: No homing error 1: Homing error occurred
pErrorCode	DWORD*	Error information on the executed function

<b>Return Value</b>	BOOL	Nonzero if successful; otherwise "0"
---------------------	------	--------------------------------------

### 5.7.8 VCS\_WaitForHomingAttained

**FUNCTION**

BOOL VCS\_WaitForHomingAttained(HANDLE KeyHandle, WORD NodeId, DWORD Timeout, DWORD\* pErrorCode)

**DESCRIPTION**

VCS\_WaitForHomingAttained waits until the homing mode is successfully terminated or until the time has elapsed.

**PARAMETERS**

KeyHandle	HANDLE	Handle for port access
NodeId	WORD	Node-ID of the addressed device
Timeout	DWORD	Max. wait time [ms] until target reached

**RETURN PARAMETERS**

pErrorCode	DWORD*	Error information on the executed function
------------	--------	--

<b>Return Value</b>	BOOL	Nonzero if successful; otherwise "0"
---------------------	------	--------------------------------------

## 5.8 Interpolated Position Mode (IPM)

### 5.8.1 VCS\_ActivateInterpolatedPositionMode

**FUNCTION**

BOOL VCS\_ActivateInterpolatedPositionMode(HANDLE KeyHandle, WORD NodeId, DWORD\* pErrorCode)

**DESCRIPTION**

VCS\_ActivateInterpolatedPositionMode changes the operational mode to “interpolated position mode”.

**PARAMETERS**

KeyHandle	HANDLE	Handle for port access
NodeId	WORD	Node-ID of the addressed device

**RETURN PARAMETERS**

pErrorCode	DWORD*	Error information on the executed function
------------	--------	--

<b>Return Value</b>	BOOL	Nonzero if successful; otherwise “0”
---------------------	------	--------------------------------------

### 5.8.2 VCS\_SetIpmBufferParameter

**FUNCTION**

BOOL VCS\_SetIpmBufferParameter(HANDLE KeyHandle, WORD NodeId, WORD UnderflowWarningLimit, WORD OverflowWarningLimit, DWORD\* pErrorCode)

**DESCRIPTION**

VCS\_SetIpmBufferParameter sets warning borders of the data input.

**PARAMETERS**

KeyHandle	HANDLE	Handle for port access
NodeId	WORD	Node-ID of the addressed device
UnderflowWarningLimit	WORD	Gives lower signalization level of the data input FIFO
OverflowWarningLimit	WORD	Gives the higher signalization level of the data input FIFO

**RETURN PARAMETERS**

pErrorCode	DWORD*	Error information on the executed function
------------	--------	--

<b>Return Value</b>	BOOL	Nonzero if successful; otherwise “0”
---------------------	------	--------------------------------------

### 5.8.3 VCS\_GetIpmBufferParameter

**FUNCTION**

BOOL VCS\_GetIpmBufferParameter(HANDLE KeyHandle, WORD NodeId, WORD\* pUnderflowWarningLimit, WORD\* pOverflowWarningLimit, DWORD\* pMaxBufferSize, DWORD\* pErrorCode)

**DESCRIPTION**

VCS\_GetIpmBufferParameter reads warning borders and the max. buffer size of the data input.

**PARAMETERS**

KeyHandle	HANDLE	Handle for port access
NodeId	WORD	Node-ID of the addressed device

**RETURN PARAMETERS**

pUnderflowWarningLimit	WORD*	Gives lower signalization level of the data input FIFO
pOverflowWarningLimit	WORD*	Gives the higher signalization level of the data input FIFO
pMaxBufferSize	DWORD*	Provides the maximal buffer size
pErrorCode	DWORD*	Error information on the executed function

<b>Return Value</b>	BOOL	Nonzero if successful; otherwise "0"
---------------------	------	--------------------------------------

### 5.8.4 VCS\_ClearIpmBuffer

**FUNCTION**

BOOL VCS\_ClearIpmBuffer(HANDLE KeyHandle, WORD NodeId, DWORD\* pErrorCode)

**DESCRIPTION**

VCS\_ClearIpmBuffer clears the input buffer and enables access to the input buffer for drive functions.

**PARAMETERS**

KeyHandle	HANDLE	Handle for port access
NodeId	WORD	Node-ID of the addressed device

**RETURN PARAMETERS**

pErrorCode	DWORD*	Error information on the executed function
------------	--------	--

<b>Return Value</b>	BOOL	Nonzero if successful; otherwise "0"
---------------------	------	--------------------------------------

**5.8.5 VCS\_GetFreeIpmBufferSize****FUNCTION**

BOOL VCS\_GetFreeIpmBufferSize(HANDLE KeyHandle, WORD NodeId, DWORD\* pBufferSize, DWORD\* pErrorCode)

**DESCRIPTION**

VCS\_GetFreeIpmBufferSize reads the available buffer size.

**PARAMETERS**

KeyHandle	HANDLE	Handle for port access
NodeId	WORD	Node-ID of the addressed device

**RETURN PARAMETERS**

pBufferSize	DWORD*	Actual free buffer size
pErrorCode	DWORD*	Error information on the executed function

<b>Return Value</b>	BOOL	Nonzero if successful; otherwise "0"
---------------------	------	--------------------------------------

**5.8.6 VCS\_AddPvtValueToIpmBuffer****FUNCTION**

BOOL VCS\_AddPvtValueToIpmBuffer(HANDLE KeyHandle, WORD NodeId, long Position, long Velocity, BYTE Time, DWORD\* pErrorCode)

**DESCRIPTION**

VCS\_AddPvtValueToIpmBuffer adds a new PVT reference point to the device.

**PARAMETERS**

KeyHandle	HANDLE	Handle for port access
NodeId	WORD	Node-ID of the addressed device
Position	long	Position of the reference point
Velocity	long	Velocity of the reference point
Time	BYTE	Time of the reference point

**RETURN PARAMETERS**

pErrorCode	DWORD*	Error information on the executed function
------------	--------	--

<b>Return Value</b>	BOOL	Nonzero if successful; otherwise "0"
---------------------	------	--------------------------------------

## 5.8.7 VCS\_StartIpmTrajectory

**FUNCTION**

BOOL VCS\_StartIpmTrajectory(HANDLE KeyHandle, WORD NodeId, DWORD\* pErrorCode)

**DESCRIPTION**

VCS\_StartIpmTrajectory starts the IPM trajectory.

**PARAMETERS**

KeyHandle	HANDLE	Handle for port access
NodeId	WORD	Node-ID of the addressed device

**RETURN PARAMETERS**

pErrorCode	DWORD*	Error information on the executed function
------------	--------	--

<b>Return Value</b>	BOOL	Nonzero if successful; otherwise "0"
---------------------	------	--------------------------------------

## 5.8.8 VCS\_StopIpmTrajectory

**FUNCTION**

BOOL VCS\_StopIpmTrajectory(HANDLE KeyHandle, WORD NodeId, DWORD\* pErrorCode)

**DESCRIPTION**

VCS\_StopIpmTrajectory stops the IPM trajectory.

**PARAMETERS**

KeyHandle	HANDLE	Handle for port access
NodeId	WORD	Node-ID of the addressed device

**RETURN PARAMETERS**

pErrorCode	DWORD*	Error information on the executed function
------------	--------	--

<b>Return Value</b>	BOOL	Nonzero if successful; otherwise "0"
---------------------	------	--------------------------------------



## 5.8.9 VCS\_GetIpmStatus

### FUNCTION

BOOL VCS\_GetIpmStatus(HANDLE KeyHandle, WORD NodeId, BOOL\* pTrajectoryRunning, BOOL\* plsUnderflowWarning, BOOL\* plsOverflowWarning, BOOL\* plsVelocityWarning, BOOL\* plsAccelerationWarning, BOOL\* plsUnderflowError, BOOL\* plsOverflowError, BOOL\* plsVelocityError, BOOL\* plsAccelerationError, DWORD\* pErrorCode)

### DESCRIPTION

VCS\_GetIpmStatus returns different warning and error states.

### PARAMETERS

KeyHandle	HANDLE	Handle for port access
NodeId	WORD	Node-ID of the addressed device

### RETURN PARAMETERS

pTrajectoryRunning	BOOL*	State if IPM active
plsUnderflowWarning	BOOL*	State if buffer underflow level is reached
plsOverflowWarning	BOOL*	State if buffer overflow level is reached
plsVelocityWarning	BOOL*	State if IPM velocity greater than profile velocity
plsAccelerationWarning	BOOL*	State if IPM acceleration greater than profile acceleration
plsUnderflowError	BOOL*	State of underflow error
plsOverflowError	BOOL*	State of overflow error
plsVelocityError	BOOL*	State if IPM velocity greater than max. profile velocity
plsAccelerationError	BOOL*	State if IPM acceleration greater than max. profile acceleration
pErrorCode	DWORD*	Error information on the executed function

<b>Return Value</b>	BOOL	Nonzero if successful; otherwise "0"
---------------------	------	--------------------------------------

## 5.9 Position Mode (PM)

### 5.9.1 VCS\_ActivatePositionMode

**FUNCTION**

BOOL VCS\_ActivatePositionMode(HANDLE KeyHandle, WORD NodeId, DWORD\* pErrorCode)

**DESCRIPTION**

VCS\_ActivatePositionMode changes the operational mode to "position mode".

**PARAMETERS**

KeyHandle	HANDLE	Handle for port access
NodeId	WORD	Node-ID of the addressed device

**RETURN PARAMETERS**

pErrorCode	DWORD*	Error information on the executed function
------------	--------	--

<b>Return Value</b>	BOOL	Nonzero if successful; otherwise "0"
---------------------	------	--------------------------------------

### 5.9.2 VCS\_SetPositionMust

**FUNCTION**

BOOL VCS\_SetPositionMust(HANDLE KeyHandle, WORD NodeId, long PositionMust, DWORD\* pErrorCode)

**DESCRIPTION**

VCS\_SetPositionMust sets the position mode setting value.

**PARAMETERS**

KeyHandle	HANDLE	Handle for port access
NodeId	WORD	Node-ID of the addressed device
PositionMust	long	Position mode setting value

**RETURN PARAMETERS**

pErrorCode	DWORD*	Error information on the executed function
------------	--------	--

<b>Return Value</b>	BOOL	Nonzero if successful; otherwise "0"
---------------------	------	--------------------------------------

**5.9.3 VCS\_GetPositionMust****FUNCTION**

BOOL VCS\_GetPositionMust(HANDLE KeyHandle, WORD NodeId, long\* pPositionMust, DWORD\* pErrorCode)

**DESCRIPTION**

VCS\_GetPositionMust reads the position mode setting value.

**PARAMETERS**

KeyHandle	HANDLE	Handle for port access
NodeId	WORD	Node-ID of the addressed device

**RETURN PARAMETERS**

pPositionMust	long*	Position mode setting value
pErrorCode	DWORD*	Error information on the executed function

<b>Return Value</b>	BOOL	Nonzero if successful; otherwise "0"
---------------------	------	--------------------------------------

**5.9.4 Advanced Functions****5.9.4.1 VCS\_ActivateAnalogPositionSetpoint****FUNCTION**

BOOL VCS\_ActivateAnalogPositionSetpoint(HANDLE KeyHandle, WORD NodeId, WORD AnalogInputNumber, float Scaling, long Offset, DWORD\* pErrorCode)

**DESCRIPTION**

VCS\_ActivateAnalogPositionSetpoint configures the selected analog input for analog position setpoint.

**PARAMETERS**

KeyHandle	HANDLE	Handle for port access
NodeId	WORD	Node-ID of the addressed device
AnalogInputNumber	WORD	Number of the used analog input
Scaling	float	Scaling factor for analog position setpoint functionality
Offset	long	Offset for analog position setpoint functionality

**RETURN PARAMETERS**

pErrorCode	DWORD*	Error information on the executed function
------------	--------	--

<b>Return Value</b>	BOOL	Nonzero if successful; otherwise "0"
---------------------	------	--------------------------------------

### 5.9.4.2 VCS\_DeactivateAnalogPositionSetpoint

**FUNCTION**

BOOL VCS\_DeactivateAnalogPositionSetpoint(HANDLE KeyHandle, WORD NodeId, WORD AnalogInputNumber, DWORD\* pErrorCode)

**DESCRIPTION**

VCS\_DeactivateAnalogPositionSetpoint disables the selected analog input for analog position setpoint.

**PARAMETERS**

KeyHandle	HANDLE	Handle for port access
NodeId	WORD	Node-ID of the addressed device
AnalogInputNumber	WORD	Number of the used analog input

**RETURN PARAMETERS**

pErrorCode	DWORD*	Error information on the executed function
------------	--------	--

<b>Return Value</b>	BOOL	Nonzero if successful; otherwise "0"
---------------------	------	--------------------------------------

### 5.9.4.3 VCS\_EnableAnalogPositionSetpoint

**FUNCTION**

BOOL VCS\_EnableAnalogPositionSetpoint(HANDLE KeyHandle, WORD NodeId, DWORD\* pErrorCode)

**DESCRIPTION**

VCS\_EnableAnalogPositionSetpoint enables the execution mask for analog position setpoint.

**PARAMETERS**

KeyHandle	HANDLE	Handle for port access
NodeId	WORD	Node-ID of the addressed device

**RETURN PARAMETERS**

pErrorCode	DWORD*	Error information on the executed function
------------	--------	--

<b>Return Value</b>	BOOL	Nonzero if successful; otherwise "0"
---------------------	------	--------------------------------------

**5.9.4.4 VCS\_DisableAnalogPositionSetpoint****FUNCTION**

BOOL VCS\_DisableAnalogPositionSetpoint(HANDLE KeyHandle, WORD NodeId, DWORD\* pErrorCode)

**DESCRIPTION**

VCS\_DisableAnalogPositionSetpoint disables the execution mask for analog position setpoint.

**PARAMETERS**

KeyHandle	HANDLE	Handle for port access
NodeId	WORD	Node-ID of the addressed device

**RETURN PARAMETERS**

pErrorCode	DWORD*	Error information on the executed function
------------	--------	--

<b>Return Value</b>	BOOL	Nonzero if successful; otherwise "0"
---------------------	------	--------------------------------------

## 5.10 Velocity Mode (VM)

### 5.10.1 VCS\_ActivateVelocityMode

**FUNCTION**

BOOL VCS\_ActivateVelocityMode(HANDLE KeyHandle, WORD NodeId, DWORD\* pErrorCode)

**DESCRIPTION**

VCS\_ActivateVelocityMode changes the operational mode to “velocity mode”.

**PARAMETERS**

KeyHandle	HANDLE	Handle for port access
NodeId	WORD	Node-ID of the addressed device

**RETURN PARAMETERS**

pErrorCode	DWORD*	Error information on the executed function
------------	--------	--

<b>Return Value</b>	BOOL	Nonzero if successful; otherwise “0”
---------------------	------	--------------------------------------

### 5.10.2 VCS\_SetVelocityMust

**FUNCTION**

BOOL VCS\_SetVelocityMust(HANDLE KeyHandle, WORD NodeId, long VelocityMust, DWORD\* pErrorCode)

**DESCRIPTION**

VCS\_SetVelocityMust sets the velocity mode setting value. The velocity is interpreted according to the currently configured velocity unit.

**PARAMETERS**

KeyHandle	HANDLE	Handle for port access
NodeId	WORD	Node-ID of the addressed device
VelocityMust	long	Velocity mode setting value

**RETURN PARAMETERS**

pErrorCode	DWORD*	Error information on the executed function
------------	--------	--

<b>Return Value</b>	BOOL	Nonzero if successful; otherwise “0”
---------------------	------	--------------------------------------

**5.10.3 VCS\_GetVelocityMust****FUNCTION**

BOOL VCS\_GetVelocityMust(HANDLE KeyHandle, WORD NodeId, long\* pVelocityMust, DWORD\* pErrorCode)

**DESCRIPTION**

VCS\_GetVelocityMust returns the velocity mode setting value. The velocity is interpreted according to the currently configured velocity unit.

**PARAMETERS**

KeyHandle	HANDLE	Handle for port access
NodeId	WORD	Node-ID of the addressed device

**RETURN PARAMETERS**

pVelocityMust	long*	Velocity mode setting value
pErrorCode	DWORD*	Error information on the executed function

<b>Return Value</b>	BOOL	Nonzero if successful; otherwise "0"
---------------------	------	--------------------------------------

**5.10.4 Advanced Functions****5.10.4.1 VCS\_ActivateAnalogVelocitySetpoint****FUNCTION**

BOOL VCS\_ActivateAnalogVelocitySetpoint(HANDLE KeyHandle, WORD NodeId, WORD AnalogInputNumber, float Scaling, long Offset, DWORD\* pErrorCode)

**DESCRIPTION**

VCS\_ActivateAnalogVelocitySetpoint configures the selected analog input for analog velocity setpoint.

**PARAMETERS**

KeyHandle	HANDLE	Handle for port access
NodeId	WORD	Node-ID of the addressed device
AnalogInputNumber	WORD	Number of the used analog input
Scaling	float	Scaling factor for analog velocity setpoint functionality
Offset	long	Offset for analog velocity setpoint functionality

**RETURN PARAMETERS**

pErrorCode	DWORD*	Error information on the executed function
------------	--------	--

<b>Return Value</b>	BOOL	Nonzero if successful; otherwise "0"
---------------------	------	--------------------------------------

### 5.10.4.2 VCS\_DeactivateAnalogVelocitySetpoint

**FUNCTION**

BOOL VCS\_DeactivateAnalogVelocitySetpoint(HANDLE KeyHandle, WORD NodeId, WORD AnalogInputNumber, DWORD\* pErrorCode)

**DESCRIPTION**

VCS\_DeactivateAnalogVelocitySetpoint disables the selected analog input for analog velocity setpoint.

**PARAMETERS**

KeyHandle	HANDLE	Handle for port access
NodeId	WORD	Node-ID of the addressed device
AnalogInputNumber	WORD	Number of the used analog input

**RETURN PARAMETERS**

pErrorCode	DWORD*	Error information on the executed function
------------	--------	--

<b>Return Value</b>	BOOL	Nonzero if successful; otherwise "0"
---------------------	------	--------------------------------------

### 5.10.4.3 VCS\_EnableAnalogVelocitySetpoint

**FUNCTION**

BOOL VCS\_EnableAnalogVelocitySetpoint(HANDLE KeyHandle, WORD NodeId, DWORD\* pErrorCode)

**DESCRIPTION**

VCS\_EnableAnalogVelocitySetpoint enables the execution mask for analog velocity setpoint.

**PARAMETERS**

KeyHandle	HANDLE	Handle for port access
NodeId	WORD	Node-ID of the addressed device

**RETURN PARAMETERS**

pErrorCode	DWORD*	Error information on the executed function
------------	--------	--

<b>Return Value</b>	BOOL	Nonzero if successful; otherwise "0"
---------------------	------	--------------------------------------



## 5.10.4.4 VCS\_DisableAnalogVelocitySetpoint

### FUNCTION

BOOL VCS\_DisableAnalogVelocitySetpoint(HANDLE KeyHandle, WORD NodeId, DWORD\* pErrorCode)

### DESCRIPTION

VCS\_DisableAnalogVelocitySetpoint disables the execution mask for analog velocity setpoint.

### PARAMETERS

KeyHandle	HANDLE	Handle for port access
NodeId	WORD	Node-ID of the addressed device

### RETURN PARAMETERS

pErrorCode	DWORD*	Error information on the executed function
------------	--------	--

<b>Return Value</b>	BOOL	Nonzero if successful; otherwise "0"
---------------------	------	--------------------------------------

## 5.11 Current Mode (CM)

### 5.11.1 VCS\_ActivateCurrentMode

**FUNCTION**

BOOL VCS\_ActivateCurrentMode(HANDLE KeyHandle, WORD NodeId, DWORD\* pErrorCode)

**DESCRIPTION**

VCS\_ActivateCurrentMode changes the operational mode to “current mode”.

**PARAMETERS**

KeyHandle	HANDLE	Handle for port access
NodeId	WORD	Node-ID of the addressed device

**RETURN PARAMETERS**

pErrorCode	DWORD*	Error information on the executed function
------------	--------	--

<b>Return Value</b>	BOOL	Nonzero if successful; otherwise “0”
---------------------	------	--------------------------------------

### 5.11.2 VCS\_GetCurrentMust

**FUNCTION**

BOOL VCS\_GetCurrentMust(HANDLE KeyHandle, WORD NodeId, short\* pCurrentMust, DWORD\* pErrorCode)

**DESCRIPTION**

VCS\_GetCurrentMust reads the current mode setting value.

**PARAMETERS**

KeyHandle	HANDLE	Handle for port access
NodeId	WORD	Node-ID of the addressed device

**RETURN PARAMETERS**

pCurrentMust	short*	Current mode setting value
pErrorCode	DWORD*	Error information on the executed function

<b>Return Value</b>	BOOL	Nonzero if successful; otherwise “0”
---------------------	------	--------------------------------------

**5.11.3 VCS\_SetCurrentMust****FUNCTION**

BOOL VCS\_SetCurrentMust(HANDLE KeyHandle, WORD NodeId, short CurrentMust, DWORD\* pErrorCode)

**DESCRIPTION**

VCS\_SetCurrentMust writes current mode setting value.

**PARAMETERS**

KeyHandle	HANDLE	Handle for port access
NodeId	WORD	Node-ID of the addressed device
CurrentMust	short	Current mode setting value

**RETURN PARAMETERS**

pErrorCode	DWORD*	Error information on the executed function
------------	--------	--

<b>Return Value</b>	BOOL	Nonzero if successful; otherwise "0"
---------------------	------	--------------------------------------

**5.11.4 Advanced Functions****5.11.4.1 VCS\_ActivateAnalogCurrentSetpoint****FUNCTION**

BOOL VCS\_ActivateAnalogCurrentSetpoint(HANDLE KeyHandle, WORD NodeId, WORD AnalogInputNumber, float Scaling, short Offset, DWORD\* pErrorCode)

**DESCRIPTION**

VCS\_ActivateAnalogCurrentSetpoint configures the selected analog input for analog current setpoint.

**PARAMETERS**

KeyHandle	HANDLE	Handle for port access
NodeId	WORD	Node-ID of the addressed device
AnalogInputNumber	WORD	Number of the used analog input
Scaling	float	Scaling factor for analog current setpoint functionality
Offset	short	Offset for analog current setpoint functionality

**RETURN PARAMETERS**

pErrorCode	DWORD*	Error information on the executed function
------------	--------	--

<b>Return Value</b>	BOOL	Nonzero if successful; otherwise "0"
---------------------	------	--------------------------------------

### 5.11.4.2 VCS\_DeactivateAnalogCurrentSetpoint

**FUNCTION**

BOOL VCS\_DeactivateAnalogCurrentSetpoint(HANDLE KeyHandle, WORD NodeId, WORD AnalogInputNumber, DWORD\* pErrorCode)

**DESCRIPTION**

VCS\_DeactivateAnalogCurrentSetpoint disables the selected analog input for analog current setpoint.

**PARAMETERS**

KeyHandle	HANDLE	Handle for port access
NodeId	WORD	Node-ID of the addressed device
AnalogInputNumber	WORD	Number of the used analog input

**RETURN PARAMETERS**

pErrorCode	DWORD*	Error information on the executed function
------------	--------	--

<b>Return Value</b>	BOOL	Nonzero if successful; otherwise "0"
---------------------	------	--------------------------------------

### 5.11.4.3 VCS\_EnableAnalogCurrentSetpoint

**FUNCTION**

BOOL VCS\_EnableAnalogCurrentSetpoint(HANDLE KeyHandle, WORD NodeId, DWORD\* pErrorCode)

**DESCRIPTION**

VCS\_EnableAnalogCurrentSetpoint enables the execution mask for analog current setpoint.

**PARAMETERS**

KeyHandle	HANDLE	Handle for port access
NodeId	WORD	Node-ID of the addressed device

**RETURN PARAMETERS**

pErrorCode	DWORD*	Error information on the executed function
------------	--------	--

<b>Return Value</b>	BOOL	Nonzero if successful; otherwise "0"
---------------------	------	--------------------------------------

## 5.11.4.4 VCS\_DisableAnalogCurrentSetpoint

### FUNCTION

BOOL VCS\_DisableAnalogCurrentSetpoint(HANDLE KeyHandle, WORD NodeId, DWORD\* pErrorCode)

### DESCRIPTION

VCS\_DisableAnalogCurrentSetpoint disables the execution mask for analog current setpoint.

### PARAMETERS

KeyHandle	HANDLE	Handle for port access
NodeId	WORD	Node-ID of the addressed device

### RETURN PARAMETERS

pErrorCode	DWORD*	Error information on the executed function
------------	--------	--

<b>Return Value</b>	BOOL	Nonzero if successful; otherwise "0"
---------------------	------	--------------------------------------

## 5.12 Master Encoder Mode (MEM)

### 5.12.1 VCS\_ActivateMasterEncoderMode

**FUNCTION**

BOOL VCS\_ActivateMasterEncoderMode(HANDLE KeyHandle, WORD NodeId, DWORD\* pErrorCode)

**DESCRIPTION**

VCS\_ActivateMasterEncoderMode changes the operational mode to “master encoder mode”.

**PARAMETERS**

KeyHandle	HANDLE	Handle for port access
NodeId	WORD	Node-ID of the addressed device

**RETURN PARAMETERS**

pErrorCode	DWORD*	Error information on the executed function
------------	--------	--

<b>Return Value</b>	BOOL	Nonzero if successful; otherwise “0”
---------------------	------	--------------------------------------

### 5.12.2 VCS\_SetMasterEncoderParameter

**FUNCTION**

BOOL VCS\_SetMasterEncoderParameter(HANDLE KeyHandle, WORD NodeId, WORD ScalingNumerator, WORD ScalingDenominator, BYTE Polarity, DWORD MaxVelocity, DWORD MaxAcceleration, DWORD\* pErrorCode)

**DESCRIPTION**

VCS\_SetMasterEncoderParameter writes all parameters for master encoder mode.

**PARAMETERS**

KeyHandle	HANDLE	Handle for port access
NodeId	WORD	Node-ID of the addressed device
ScalingNumerator	WORD	Scaling numerator for position calculation
ScalingDenominator	WORD	Scaling denominator for position calculation
Polarity	BYTE	Polarity of the direction input. 0: Positive 1: Negative
MaxVelocity	DWORD	Maximal allowed speed during a profiled move. Given in velocity units.
MaxAcceleration	DWORD	Defines the maximal allowed acceleration

**RETURN PARAMETERS**

pErrorCode	DWORD*	Error information on the executed function
------------	--------	--

<b>Return Value</b>	BOOL	Nonzero if successful; otherwise “0”
---------------------	------	--------------------------------------

**5.12.3 VCS\_GetMasterEncoderParameter****FUNCTION**

BOOL VCS\_GetMasterEncoderParameter(HANDLE KeyHandle, WORD NodeId, WORD\* pScalingNumerator, WORD\* pScalingDenominator, BYTE\* pPolarity, DWORD\* pMaxVelocity, DWORD\* pMaxAcceleration, DWORD\* pErrorCode)

**DESCRIPTION**

VCS\_GetMasterEncoderParameter reads all parameters for master encoder mode.

**PARAMETERS**

KeyHandle	HANDLE	Handle for port access
NodeId	WORD	Node-ID of the addressed device

**RETURN PARAMETERS**

pScalingNumerator	WORD*	Scaling numerator for position calculation
pScalingDenominator	WORD*	Scaling denominator for position calculation
pPolarity	BYTE*	Polarity of the direction input. 0: Positive 1: Negative
pMaxVelocity	DWORD*	Maximal allowed speed during a profiled move. Given in velocity units.
pMaxAcceleration	DWORD*	Defines the maximal allowed acceleration
pErrorCode	DWORD*	Error information on the executed function

<b>Return Value</b>	BOOL	Nonzero if successful; otherwise "0"
---------------------	------	--------------------------------------

## 5.13 Step Direction Mode (SDM)

### 5.13.1 VCS\_ActivateStepDirectionMode

**FUNCTION**

BOOL VCS\_ActivateStepDirectionMode(HANDLE KeyHandle, WORD NodeId, DWORD\* pErrorCode)

**DESCRIPTION**

VCS\_ActivateStepDirectionMode changes the operational mode to “step direction mode”.

**PARAMETERS**

KeyHandle	HANDLE	Handle for port access
NodeId	WORD	Node-ID of the addressed device

**RETURN PARAMETERS**

pErrorCode	DWORD*	Error information on the executed function
------------	--------	--

<b>Return Value</b>	BOOL	Nonzero if successful; otherwise “0”
---------------------	------	--------------------------------------

### 5.13.2 VCS\_SetStepDirectionParameter

**FUNCTION**

BOOL VCS\_SetStepDirectionParameter(HANDLE KeyHandle, WORD NodeId, WORD ScalingNumerator, WORD ScalingDenominator, BYTE Polarity, DWORD MaxVelocity, DWORD MaxAcceleration, DWORD\* pErrorCode)

**DESCRIPTION**

VCS\_SetStepDirectionParameter writes all parameters for step direction mode.

**PARAMETERS**

KeyHandle	HANDLE	Handle for port access
NodeId	WORD	Node-ID of the addressed device
ScalingNumerator	WORD	Scaling numerator for position calculation
ScalingDenominator	WORD	Scaling denominator for position calculation
Polarity	BYTE	Polarity of the direction input. 0: Positive 1: Negative
MaxVelocity	DWORD	Maximal allowed speed during a profiled move. Given in velocity units.
MaxAcceleration	DWORD	Defines the maximal allowed acceleration

**RETURN PARAMETERS**

pErrorCode	DWORD*	Error information on the executed function
------------	--------	--

<b>Return Value</b>	BOOL	Nonzero if successful; otherwise “0”
---------------------	------	--------------------------------------



**5.13.3 VCS\_GetStepDirectionParameter****FUNCTION**

BOOL VCS\_GetStepDirectionParameter(HANDLE KeyHandle, WORD NodeId, WORD\* pScalingNumerator, WORD\* pScalingDenominator, BYTE\* pPolarity, DWORD\* pMaxVelocity, DWORD\* pMaxAcceleration, DWORD\* pErrorCode)

**DESCRIPTION**

VCS\_GetStepDirectionParameter reads all parameters for step direction mode.

**PARAMETERS**

KeyHandle	HANDLE	Handle for port access
NodeId	WORD	Node-ID of the addressed device

**RETURN PARAMETERS**

pScalingNumerator	WORD*	Scaling numerator for position calculation
pScalingDenominator	WORD*	Scaling denominator for position calculation
pPolarity	BYTE*	Polarity of the direction input. 0: Positive 1: Negative
pMaxVelocity	DWORD*	Maximal allowed speed during a profiled move. Given in velocity units.
pMaxAcceleration	DWORD*	Defines the maximal allowed acceleration
pErrorCode	DWORD*	Error information on the executed function

<b>Return Value</b>	BOOL	Nonzero if successful; otherwise "0"
---------------------	------	--------------------------------------

## 5.14 Inputs & Outputs

For details → separate document «Firmware Specification».

### 5.14.1 VCS\_GetAllDigitalInputs

**FUNCTION**

BOOL VCS\_GetAllDigitalInputs(HANDLE KeyHandle, WORD NodeId, WORD\* pInputs, DWORD\* pErrorCode)

**DESCRIPTION**

VCS\_GetAllDigitalInputs returns state of all digital inputs.

**PARAMETERS**

KeyHandle	HANDLE	Handle for port access
NodeId	WORD	Node-ID of the addressed device

**RETURN PARAMETERS**

pInputs	WORD*	Displays the state of the digital input functionalities. Activated if a bit is read as "1". → Figure 5-20 for "tInputs" structure
pErrorCode	DWORD*	Error information on the executed function

<b>Return Value</b>	BOOL	Nonzero if successful; otherwise "0"
---------------------	------	--------------------------------------

```
typedef struct
{
    WORD    DI_NEGATIVE_LIMIT_SWITCH      : 1;    //Bit0
    WORD    DI_POSITIVE_LIMIT_SWITCH     : 1;    //Bit1
    WORD    DI_HOME_SWITCH                : 1;    //Bit2
    WORD    DI_POSITION_MARKER           : 1;    //Bit3
    WORD    DI_DRIVE_ENABLE               : 1;    //Bit4
    WORD    DI_QUICK_STOP                 : 1;    //Bit5
    WORD    DI_TOUCH_PROBE1              : 1;    //Bit6
    WORD    DI_NOT_USED                   : 1;    //Bit7
    WORD    DI_GENERAL_PURPOSE_H         : 1;    //Bit8
    WORD    DI_GENERAL_PURPOSE_G         : 1;    //Bit9
    WORD    DI_GENERAL_PURPOSE_F         : 1;    //Bit10
    WORD    DI_GENERAL_PURPOSE_E         : 1;    //Bit11
    WORD    DI_GENERAL_PURPOSE_D         : 1;    //Bit12
    WORD    DI_GENERAL_PURPOSE_C         : 1;    //Bit13
    WORD    DI_GENERAL_PURPOSE_B         : 1;    //Bit14
    WORD    DI_GENERAL_PURPOSE_A         : 1;    //Bit15
} tInputs;
```

Figure 5-20 VCS\_GetAllDigitalInputs (tInputs)

5.14.2 VCS\_GetAllDigitalOutputs

FUNCTION

BOOL VCS\_GetAllDigitalOutputs(HANDLE KeyHandle, WORD NodeId, WORD\* pOutputs, DWORD\* pErrorCode)

DESCRIPTION

VCS\_GetAllDigitalOutputs returns state of all digital outputs.

PARAMETERS

KeyHandle	HANDLE	Handle for port access
NodeId	WORD	Node-ID of the addressed device

RETURN PARAMETERS

pOutputs	WORD*	State of all digital outputs. Activated if a bit is read as "1". → Figure 5-21 for "tOutputs" structure
pErrorCode	DWORD*	Error information on the executed function

Return Value	BOOL	Nonzero if successful; otherwise "0"
--------------	------	--------------------------------------

```
typedef struct
{
    WORD DO_READY_FAULT : 1; //Bit0
    WORD DO_POSITION_COMPARE : 1; //Bit1
    WORD DO_HOLDING_BRAKE : 1; //Bit2
    WORD DO_NOT_USED1 : 1; //Bit3
    WORD DO_NOT_USED2 : 1; //Bit4
    WORD DO_NOT_USED3 : 1; //Bit5
    WORD DO_NOT_USED4 : 1; //Bit6
    WORD DO_SET_BRAKE : 1; //Bit7
    WORD DO_GENERAL_PURPOSE_H : 1; //Bit8
    WORD DO_GENERAL_PURPOSE_G : 1; //Bit9
    WORD DO_GENERAL_PURPOSE_F : 1; //Bit10
    WORD DO_GENERAL_PURPOSE_E : 1; //Bit11
    WORD DO_GENERAL_PURPOSE_D : 1; //Bit12
    WORD DO_GENERAL_PURPOSE_C : 1; //Bit13
    WORD DO_GENERAL_PURPOSE_B : 1; //Bit14
    WORD DO_GENERAL_PURPOSE_A : 1; //Bit15
} tOutputs;
```

Figure 5-21 VCS\_GetAllDigitalOutputs (tOutputs)

### 5.14.3 VCS\_SetAllDigitalOutputs

**FUNCTION**

BOOL VCS\_SetAllDigitalOutputs(HANDLE KeyHandle, WORD NodeId, WORD Outputs, DWORD\* pErrorCode)

**DESCRIPTION**

VCS\_SetAllDigitalOutputs sets the state of all digital outputs.

**PARAMETERS**

KeyHandle	HANDLE	Handle for port access
NodeId	WORD	Node-ID of the addressed device
Outputs	WORD	State of all digital outputs. Activated if a bit is written as "1". →Figure 5-22 for "tOutputs" structure

**RETURN PARAMETERS**

pErrorCode	DWORD*	Error information on the executed function
------------	--------	--

<b>Return Value</b>	BOOL	Nonzero if successful; otherwise "0"
---------------------	------	--------------------------------------

```
typedef struct
{
    WORD DO_READY_FAULT           : 1;      //Bit0 (ReadOnly)
    WORD DO_POSITION_COMPARE      : 1;      //Bit1 (ReadOnly)
    WORD DO_HOLDING_BRAKE         : 1;      //Bit2 (ReadOnly)
    WORD DO_NOT_USED1             : 1;      //Bit3
    WORD DO_NOT_USED2             : 1;      //Bit4
    WORD DO_NOT_USED3             : 1;      //Bit5
    WORD DO_NOT_USED4             : 1;      //Bit6
    WORD DO_SET_BRAKE             : 1;      //Bit7
    WORD DO_GENERAL_PURPOSE_H     : 1;      //Bit8
    WORD DO_GENERAL_PURPOSE_G     : 1;      //Bit9
    WORD DO_GENERAL_PURPOSE_F     : 1;      //Bit10
    WORD DO_GENERAL_PURPOSE_E     : 1;      //Bit11
    WORD DO_GENERAL_PURPOSE_D     : 1;      //Bit12
    WORD DO_GENERAL_PURPOSE_C     : 1;      //Bit13
    WORD DO_GENERAL_PURPOSE_B     : 1;      //Bit14
    WORD DO_GENERAL_PURPOSE_A     : 1;      //Bit15
} tOutputs;
```

Figure 5-22 VCS\_SetAllDigitalOutputs (tOutputs)

**5.14.4 VCS\_GetAnalogInput****FUNCTION**

BOOL VCS\_GetAnalogInput(HANDLE KeyHandle, WORD NodeId, WORD InputNumber, WORD\* pAnalogValue, DWORD\* pErrorCode)

**DESCRIPTION**

VCS\_GetAnalogInput returns the value from an analog input.

**PARAMETERS**

KeyHandle	HANDLE	Handle for port access
NodeId	WORD	Node-ID of the addressed device
InputNumber	WORD	Analog input number

**RETURN PARAMETERS**

pAnalogValue	WORD*	Analog value from input
pErrorCode	DWORD*	Error information on the executed function

<b>Return Value</b>	BOOL	Nonzero if successful; otherwise "0"
---------------------	------	--------------------------------------

**5.14.5 VCS\_GetAnalogInputVoltage****FUNCTION**

BOOL VCS\_GetAnalogInputVoltage(HANDLE KeyHandle, WORD NodeId, WORD InputNumber, long\* pVoltageValue, DWORD\* pErrorCode)

**DESCRIPTION**

VCS\_GetAnalogInputVoltage returns the voltage value from an analog input.

**PARAMETERS**

KeyHandle	HANDLE	Handle for port access
NodeId	WORD	Node-ID of the addressed device
InputNumber	WORD	Analog input number

**RETURN PARAMETERS**

pVoltageValue	long*	Analog voltage value from input
pErrorCode	DWORD*	Error information on the executed function

<b>Return Value</b>	BOOL	Nonzero if successful; otherwise "0"
---------------------	------	--------------------------------------

### 5.14.6 VCS\_GetAnalogInputState

**FUNCTION**

BOOL VCS\_GetAnalogInputState(HANDLE KeyHandle, WORD NodeId, WORD Configuration, long\* pStateValue, DWORD\* pErrorCode)

**DESCRIPTION**

VCS\_GetAnalogInputState returns the state value from an analog input functionality.

**PARAMETERS**

KeyHandle	HANDLE	Handle for port access
NodeId	WORD	Node-ID of the addressed device
Configuration	WORD	Analog input function configuration

**RETURN PARAMETERS**

pStateValue	long*	Analog state value from input
pErrorCode	DWORD*	Error information on the executed function

<b>Return Value</b>	BOOL	Nonzero if successful; otherwise "0"
---------------------	------	--------------------------------------

Description	Value	Name
Analog current setpoint	0	AIC_ANALOG_CURRENT_SETPOINT
Analog velocity setpoint	1	AIC_ANALOG_VELOCITY_SETPOINT
Analog position setpoint	2	AIC_ANALOG_POSITION_SETPOINT
General purpose H	8	AIC_GENERAL_PURPOSE_H
General purpose G	9	AIC_GENERAL_PURPOSE_G
General purpose F	10	AIC_GENERAL_PURPOSE_F
General purpose E	11	AIC_GENERAL_PURPOSE_E
General purpose D	12	AIC_GENERAL_PURPOSE_D
General purpose C	13	AIC_GENERAL_PURPOSE_C
General purpose B	14	AIC_GENERAL_PURPOSE_B
General purpose A	15	AIC_GENERAL_PURPOSE_A

Table 5-23 Analog input states

**5.14.7 VCS\_SetAnalogOutput****FUNCTION**

BOOL VCS\_SetAnalogOutput(HANDLE KeyHandle, WORD NodeId, WORD OutputNumber, WORD AnalogValue, DWORD\* pErrorCode)

**DESCRIPTION**

VCS\_SetAnalogOutput sets the voltage level of an analog output.

**PARAMETERS**

KeyHandle	HANDLE	Handle for port access
NodeId	WORD	Node-ID of the addressed device
OutputNumber	WORD	Analog output number
AnalogValue	WORD	Analog value for output

**RETURN PARAMETERS**

pErrorCode	DWORD*	Error information on the executed function
------------	--------	--

<b>Return Value</b>	BOOL	Nonzero if successful; otherwise "0"
---------------------	------	--------------------------------------

**5.14.8 VCS\_SetAnalogOutputVoltage****FUNCTION**

BOOL VCS\_SetAnalogOutputVoltage(HANDLE KeyHandle, WORD NodeId, WORD OutputNumber, long VoltageValue, DWORD\* pErrorCode)

**DESCRIPTION**

VCS\_SetAnalogOutputVoltage sets the voltage level of an analog output.

**PARAMETERS**

KeyHandle	HANDLE	Handle for port access
NodeId	WORD	Node-ID of the addressed device
OutputNumber	WORD	Analog output number
VoltageValue	long	Analog voltage value for output

**RETURN PARAMETERS**

pErrorCode	DWORD*	Error information on the executed function
------------	--------	--

<b>Return Value</b>	BOOL	Nonzero if successful; otherwise "0"
---------------------	------	--------------------------------------

### 5.14.9 VCS\_SetAnalogOutputState

**FUNCTION**

BOOL VCS\_SetAnalogOutputState(HANDLE KeyHandle, WORD NodeId, WORD Configuration, long StateValue, DWORD\* pErrorCode)

**DESCRIPTION**

VCS\_setAnalogOutputState sets the state value for an analog output functionality.

**PARAMETERS**

KeyHandle	HANDLE	Handle for port access
NodeId	WORD	Node-ID of the addressed device
Configuration	WORD	Analog output function configuration
StateValue	long	Analog state value for output

**RETURN PARAMETERS**

pErrorCode	DWORD*	Error information on the executed function
------------	--------	--

<b>Return Value</b>	BOOL	Nonzero if successful; otherwise "0"
---------------------	------	--------------------------------------

Description	Value	Name
General purpose A	0	AOC_GENERAL_PURPOSE_A
General purpose B	1	AOC_GENERAL_PURPOSE_B

Table 5-24 Analog output states



**5.14.10 Position Compare**

**5.14.10.1 VCS\_SetPositionCompareParameter**

**FUNCTION**

BOOL VCS\_SetPositionCompareParameter(HANDLE KeyHandle, WORD NodeId, BYTE OperationalMode, BYTE IntervalMode, BYTE DirectionDependency, WORD IntervalWidth, WORD IntervalRepetitions, WORD PulseWidth, DWORD\* pErrorCode)

**DESCRIPTION**

VCS\_SetPositionCompareParameter writes all parameters for position compare.

**PARAMETERS**

KeyHandle	HANDLE	Handle for port access
NodeId	WORD	Node-ID of the addressed device
OperationalMode	BYTE	Used operational mode in position sequence mode (→Table 5-25)
IntervalMode	BYTE	Used interval mode in position sequence mode (→Table 5-26)
DirectionDependency	BYTE	Used direction dependency in position sequence mode (→Table 5-27)
IntervalWidth	WORD	Holds the width of the position intervals
IntervalRepetitions	WORD	Allows to configure the number of position intervals to be considered by position compare
PulseWidth	WORD	Configures the pulse width of the trigger output

**RETURN PARAMETERS**

pErrorCode	DWORD*	Error information on the executed function
------------	--------	--

<b>Return Value</b>	BOOL	Nonzero if successful; otherwise "0"
---------------------	------	--------------------------------------

**OPERATIONALMODE**

Description	Value	Name
Single position mode	0	PCO_SINGLE_POSITION_MODE
Position sequence mode	1	PCO_POSITION_SEQUENCE_MODE

Table 5-25 Position compare – Operational modes

**INTERVALMODE**

Description	Value	Name
Interval positions are set in negative direction relative to the position compare reference position	0	PCI_NEGATIVE_DIR_TO_REFPOS
Interval positions are set in positive direction relative to the position compare reference position	1	PCI_POSITIVE_DIR_TO_REFPOS
Interval positions are set in positive and negative direction relative to the position compare reference position	2	PCI_BOTH_DIR_TO_REFPOS

Table 5-26 Position compare – Interval modes

Continued on next page.

**DIRECTIONDEPENDENCY**

Description	Value	Name
Positions are compared only if actual motor direction is negative	0	PCD_MOTOR_DIRECTION_NEGATIVE
Positions are compared only if actual motor direction is positive	1	PCD_MOTOR_DIRECTION_POSITIVE
Positions are compared regardless of the actual motor direction	2	PCD_MOTOR_DIRECTION_BOTH

Table 5-27 Position compare – Direction dependency

**5.14.10.2 VCS\_GetPositionCompareParameter**

**FUNCTION**

BOOL VCS\_GetPositionCompareParameter(HANDLE KeyHandle, WORD NodeId, BYTE\* pOperationalMode, BYTE\* pIntervalMode, BYTE\* pDirectionDependency, WORD\* pIntervalWidth, WORD\* pIntervalRepetitions, WORD\* pPulseWidth, DWORD\* pErrorCode)

**DESCRIPTION**

VCS\_GetPositionCompareParameter reads all parameters for position compare.

**PARAMETERS**

KeyHandle	HANDLE	Handle for port access
NodeId	WORD	Node-ID of the addressed device

**RETURN PARAMETERS**

pOperationalMode	BYTE*	Used operational mode in position sequence mode (→Table 5-25)
pIntervalMode	BYTE*	Used interval mode in position sequence mode (→Table 5-26)
pDirectionDependency	BYTE*	Used direction dependency in position sequence mode (→Table 5-27)
pIntervalWidth	WORD*	Holds the width of the position intervals
pIntervalRepetitions	WORD*	Allows to configure the number of position intervals to be considered by position compare
pPulseWidth	WORD*	Configures the pulse width of the trigger output
pErrorCode	DWORD*	Error information on the executed function

<b>Return Value</b>	BOOL	Nonzero if successful; otherwise "0"
---------------------	------	--------------------------------------

**5.14.10.3 VCS\_ActivatePositionCompare****FUNCTION**

BOOL VCS\_ActivatePositionCompare(HANDLE KeyHandle, WORD NodeId, WORD DigitalOutputNumber, BOOL Polarity, DWORD\* pErrorCode)

**DESCRIPTION**

VCS\_ActivatePositionCompare enables the output to position compare method.

**PARAMETERS**

KeyHandle	HANDLE	Handle for port access
NodeId	WORD	Node-ID of the addressed device
DigitalOutputNumber	WORD	Selected digital output for position compare
Polarity	BOOL	Polarity of the selected output

**RETURN PARAMETERS**

pErrorCode	DWORD*	Error information on the executed function
------------	--------	--

<b>Return Value</b>	BOOL	Nonzero if successful; otherwise "0"
---------------------	------	--------------------------------------

**5.14.10.4 VCS\_DeactivatePositionCompare****FUNCTION**

BOOL VCS\_DeactivatePositionCompare(HANDLE KeyHandle, WORD NodeId, WORD DigitalOutputNumber, DWORD\* pErrorCode)

**DESCRIPTION**

VCS\_DeactivatePositionCompare disables the output to position compare method.

**PARAMETERS**

KeyHandle	HANDLE	Handle for port access
NodeId	WORD	Node-ID of the addressed device
DigitalOutputNumber	WORD	Selected digital output for position compare

**RETURN PARAMETERS**

pErrorCode	DWORD*	Error information on the executed function
------------	--------	--

<b>Return Value</b>	BOOL	Nonzero if successful; otherwise "0"
---------------------	------	--------------------------------------

## 5.14.10.5 VCS\_EnablePositionCompare

### FUNCTION

BOOL VCS\_EnablePositionCompare(HANDLE KeyHandle, WORD NodeId, DWORD\* pErrorCode)

### DESCRIPTION

VCS\_EnablePositionCompare enables the output mask for position compare method.

### PARAMETERS

KeyHandle	HANDLE	Handle for port access
NodeId	WORD	Node-ID of the addressed device

### RETURN PARAMETERS

pErrorCode	DWORD*	Error information on the executed function
------------	--------	--

<b>Return Value</b>	BOOL	Nonzero if successful; otherwise "0"
---------------------	------	--------------------------------------

## 5.14.10.6 VCS\_DisablePositionCompare

### FUNCTION

BOOL VCS\_DisablePositionCompare(HANDLE KeyHandle, WORD NodeId, DWORD\* pErrorCode)

### DESCRIPTION

VCS\_DisablePositionCompare disables the output mask from position compare method.

### PARAMETERS

KeyHandle	HANDLE	Handle for port access
NodeId	WORD	Node-ID of the addressed device

### RETURN PARAMETERS

pErrorCode	DWORD*	Error information on the executed function
------------	--------	--

<b>Return Value</b>	BOOL	Nonzero if successful; otherwise "0"
---------------------	------	--------------------------------------

**5.14.10.7 VCS\_SetPositionCompareReferencePosition****FUNCTION**

BOOL VCS\_SetPositionCompareReferencePosition(HANDLE KeyHandle, WORD NodeId, long ReferencePosition, DWORD\* pErrorCode)

**DESCRIPTION**

VCS\_SetPositionCompareReferencePosition writes the reference position for position compare method.

**PARAMETERS**

KeyHandle	HANDLE	Handle for port access
NodeId	WORD	Node-ID of the addressed device
ReferencePosition	long	Holds the position that is compared with the position actual value

**RETURN PARAMETERS**

pErrorCode	DWORD*	Error information on the executed function
------------	--------	--

<b>Return Value</b>	BOOL	Nonzero if successful; otherwise "0"
---------------------	------	--------------------------------------

## 5.14.11 Position Marker

### 5.14.11.1 VCS\_SetPositionMarkerParameter

**FUNCTION**

BOOL VCS\_SetPositionMarkerParameter(HANDLE KeyHandle, WORD NodeId, BYTE PositionMarkerEdgeType, BYTE PositionMarkerMode, DWORD\* pErrorCode)

**DESCRIPTION**

VCS\_SetPositionMarkerParameter writes all parameters for position marker method.

**PARAMETERS**

KeyHandle	HANDLE	Handle for port access
NodeId	WORD	Node-ID of the addressed device
PositionMarkerEdgeType	BYTE	Defines the type of edge of the position to be captured (→Table 5-28)
PositionMarkerMode	BYTE	Defines the position marker capturing mode (→Table 5-29)

**RETURN PARAMETERS**

pErrorCode	DWORD*	Error information on the executed function
------------	--------	--

<b>Return Value</b>	BOOL	Nonzero if successful; otherwise "0"
---------------------	------	--------------------------------------

**POSITIONMARKEREDGEType**

Description	Value	Name
Both edges	0	PET_BOTH_EDGES
Rising edge	1	PET_RISING_EDGE
Falling edge	2	PET_FALLING_EDGE

Table 5-28 Position marker edge types

**POSITIONMARKERMODE**

Description	Value	Name
Continuous	0	PM_CONTINUOUS
Single	1	PM_SINGLE
Multiple	2	PM_MULTIPLE

Table 5-29 Position marker modes

**5.14.11.2 VCS\_GetPositionMarkerParameter****FUNCTION**

BOOL VCS\_GetPositionMarkerParameter(HANDLE KeyHandle, WORD NodeId, BYTE\* pPositionMarkerEdgeType, BYTE\* pPositionMarkerMode, DWORD\* pErrorCode)

**DESCRIPTION**

VCS\_GetPositionMarkerParameter reads all parameters for position marker method.

**PARAMETERS**

KeyHandle	HANDLE	Handle for port access
NodeId	WORD	Node-ID of the addressed device

**RETURN PARAMETERS**

pPositionMarkerEdgeType	BYTE*	Defines the type of edge of the position to be captured (→Table 5-28)
pPositionMarkerMode	BYTE*	Defines the position marker capturing mode (→Table 5-29)
pErrorCode	DWORD*	Error information on the executed function

<b>Return Value</b>	BOOL	Nonzero if successful; otherwise "0"
---------------------	------	--------------------------------------

**5.14.11.3 VCS\_ActivatePositionMarker****FUNCTION**

BOOL VCS\_ActivatePositionMarker(HANDLE KeyHandle, WORD NodeId, WORD DigitalInputNumber, BOOL Polarity, DWORD\* pErrorCode)

**DESCRIPTION**

VCS\_ActivatePositionMarker enables the digital input to position marker method.

**PARAMETERS**

KeyHandle	HANDLE	Handle for port access
NodeId	WORD	Node-ID of the addressed device
DigitalInputNumber	WORD	Selected digital input for position marker
Polarity	BOOL	Polarity of the selected input

**RETURN PARAMETERS**

pErrorCode	DWORD*	Error information on the executed function
------------	--------	--

<b>Return Value</b>	BOOL	Nonzero if successful; otherwise "0"
---------------------	------	--------------------------------------

### 5.14.11.4 VCS\_DeactivatePositionMarker

**FUNCTION**

BOOL VCS\_DeactivatePositionMarker(HANDLE KeyHandle, WORD NodeId, WORD DigitalInputNumber, DWORD\* pErrorCode)

**DESCRIPTION**

VCS\_DeactivatePositionMarker disables the digital input to position marker method.

**PARAMETERS**

KeyHandle	HANDLE	Handle for port access
NodeId	WORD	Node-ID of the addressed device
DigitalInputNumber	WORD	Selected digital input for position marker

**RETURN PARAMETERS**

pErrorCode	DWORD*	Error information on the executed function
------------	--------	--

<b>Return Value</b>	BOOL	Nonzero if successful; otherwise "0"
---------------------	------	--------------------------------------

### 5.14.11.5 VCS\_ReadPositionMarkerCounter

**FUNCTION**

BOOL VCS\_ReadPositionMarkerCounter(HANDLE KeyHandle, WORD NodeId, WORD\* pCount, DWORD\* pErrorCode)

**DESCRIPTION**

VCS\_ReadPositionMarkerCounter returns the number of the detected edges.

**PARAMETERS**

KeyHandle	HANDLE	Handle for port access
NodeId	WORD	Node-ID of the addressed device

**RETURN PARAMETERS**

pCount	WORD*	Counts the number of detected edges
pErrorCode	DWORD*	Error information on the executed function

<b>Return Value</b>	BOOL	Nonzero if successful; otherwise "0"
---------------------	------	--------------------------------------



**5.14.11.6 VCS\_ReadPositionMarkerCapturedPosition**

**FUNCTION**

BOOL VCS\_ReadPositionMarkerCapturedPosition(HANDLE KeyHandle, WORD NodeId, WORD CounterIndex, long\* pCapturedPosition, DWORD\* pErrorCode)

**DESCRIPTION**

VCS\_ReadPositionMarkerCapturedPosition returns the last captured position or the position from the position marker history.

**PARAMETERS**

KeyHandle	HANDLE	Handle for port access
NodeId	WORD	Node-ID of the addressed device
CounterIndex	WORD	0: Read position marker captured position
		1: Read position marker history
		2: Read position marker history

**RETURN PARAMETERS**

pCapturedPosition	long*	Contains the captured position or the position marker history
pErrorCode	DWORD*	Error information on the executed function

<b>Return Value</b>	BOOL	Nonzero if successful; otherwise "0"
---------------------	------	--------------------------------------

**5.14.11.7 VCS\_ResetPositionMarkerCounter**

**FUNCTION**

BOOL VCS\_ResetPositionMarkerCounter(HANDLE KeyHandle, WORD NodeId, DWORD\* pErrorCode)

**DESCRIPTION**

VCS\_ResetPositionMarkerCounter clears the counter and the captured positions by writing zero to object position marker counter (0x2074-04).

**PARAMETERS**

KeyHandle	HANDLE	Handle for port access
NodeId	WORD	Node-ID of the addressed device

**RETURN PARAMETERS**

pErrorCode	DWORD*	Error information on the executed function
------------	--------	--

<b>Return Value</b>	BOOL	Nonzero if successful; otherwise "0"
---------------------	------	--------------------------------------

*••page intentionally left blank••*

## 6 Data Recording Functions



### Availability of functions

The availability of certain functions depends on the used hardware. For an overview → “Appendix A — Hardware vs. Functions” on page 11-161.

Data recording functions are not available with Linux.

### 6.1 Operation Mode

#### 6.1.1 VCS\_SetRecorderParameter

##### FUNCTION

BOOL VCS\_SetRecorderParameter(HANDLE KeyHandle, WORD NodeId, WORD SamplingPeriod, WORD NbOfPrecedingSamples, DWORD\* pErrorCode)

##### DESCRIPTION

VCS\_SetRecorderParameter writes parameters for data recorder.

##### PARAMETERS

KeyHandle	HANDLE	Handle for port access
NodeId	WORD	Node-ID of the addressed device
SamplingPeriod	WORD	Sampling Period as a multiple of the current regulator cycle (n-times 0.1 ms)
NbOfPrecedingSamples	WORD	Number of preceding samples (data history)

##### RETURN PARAMETERS

pErrorCode	DWORD*	Error information on the executed function
------------	--------	--

<b>Return Value</b>	BOOL	Nonzero if successful; otherwise “0”
---------------------	------	--------------------------------------

#### 6.1.2 VCS\_GetRecorderParameter

##### FUNCTION

BOOL VCS\_GetRecorderParameter(HANDLE KeyHandle, WORD NodeId, WORD\* pSamplingPeriod, WORD\* pNbOfPrecedingSamples, DWORD\* pErrorCode)

##### DESCRIPTION

VCS\_GetRecorderParameter reads parameters for data recorder.

##### PARAMETERS

KeyHandle	HANDLE	Handle for port access
NodeId	WORD	Node-ID of the addressed device

##### RETURN PARAMETERS

pSamplingPeriod	WORD*	Sampling Period as a multiple of the current regulator cycle (n-times 0.1 ms)
pNbOfPrecedingSamples	WORD*	Number of preceding samples (data history)
pErrorCode	DWORD*	Error information on the executed function

<b>Return Value</b>	BOOL	Nonzero if successful; otherwise “0”
---------------------	------	--------------------------------------

### 6.1.3 VCS\_EnableTrigger

**FUNCTION**

BOOL VCS\_EnableTrigger(HANDLE KeyHandle, WORD NodeId, BYTE TriggerType, DWORD\* pErrorCode)

**DESCRIPTION**

VCS\_EnableTrigger connects the trigger(s) for data recording.

**PARAMETERS**

KeyHandle	HANDLE	Handle for port access
NodeId	WORD	Node-ID of the addressed device
TriggerType	BYTE	Configuration of Auto Trigger functions. Activated if a bit is written as "1" (→Table 6-30). Activation of more than one trigger at the same time is possible.

**RETURN PARAMETERS**

pErrorCode	DWORD*	Error information on the executed function
------------	--------	--

<b>Return Value</b>	BOOL	Nonzero if successful; otherwise "0"
---------------------	------	--------------------------------------

Description	Value	Name
Trigger movement start	1	DR_MOVEMENT_START_TRIGGER
Error trigger	2	DR_ERROR_TRIGGER
Digital input trigger	4	DR_DIGITAL_INPUT_TRIGGER
Trigger movement end	8	DR_MOVEMENT_END_TRIGGER

Table 6-30 Data recorder trigger types

### 6.1.4 VCS\_DisableAllTriggers

**FUNCTION**

BOOL VCS\_DisableAllTriggers(HANDLE KeyHandle, WORD NodeId, DWORD\* pErrorCode)

**DESCRIPTION**

VCS\_DisableAllTriggers sets data recorder configuration for triggers to zero.

**PARAMETERS**

KeyHandle	HANDLE	Handle for port access
NodeId	WORD	Node-ID of the addressed device

**RETURN PARAMETERS**

pErrorCode	DWORD*	Error information on the executed function
------------	--------	--

<b>Return Value</b>	BOOL	Nonzero if successful; otherwise "0"
---------------------	------	--------------------------------------

## 6.1.5 VCS\_ActivateChannel

### FUNCTION

BOOL VCS\_ActivateChannel(HANDLE KeyHandle, WORD NodeId, BYTE ChannelNumber, WORD ObjectIndex, BYTE ObjectSubIndex, BYTE ObjectSize, DWORD\* pErrorCode)

### DESCRIPTION

VCS\_ActivateChannel connects object for data recording.

Start with channel 1 (one)! Then, for every activated channel, the number of sampling variables will be incremented.

### PARAMETERS

KeyHandle	HANDLE	Handle for port access
NodeId	WORD	Node-ID of the addressed device
ChannelNumber	BYTE	Channel number [1...4]
ObjectIndex	WORD	Object index for data recording
ObjectSubIndex	BYTE	Object subindex for data recording
ObjectSize	BYTE	Object size in bytes for data recording

### RETURN PARAMETERS

pErrorCode	DWORD*	Error information on the executed function
------------	--------	--

<b>Return Value</b>	BOOL	Nonzero if successful; otherwise "0"
---------------------	------	--------------------------------------

## 6.1.6 VCS\_DeactivateAllChannels

### FUNCTION

BOOL VCS\_DeactivateAllChannels(HANDLE KeyHandle, WORD NodeId, DWORD\* pErrorCode)

### DESCRIPTION

VCS\_DeactivateAllChannels zeros all data recording objects.

### PARAMETERS

KeyHandle	HANDLE	Handle for port access
NodeId	WORD	Node-ID of the addressed device

### RETURN PARAMETERS

pErrorCode	DWORD*	Error information on the executed function
------------	--------	--

<b>Return Value</b>	BOOL	Nonzero if successful; otherwise "0"
---------------------	------	--------------------------------------

## 6.2 Data Recorder Status

### 6.2.1 VCS\_StartRecorder

**FUNCTION**

BOOL VCS\_StartRecorder(HANDLE KeyHandle, WORD NodeId, DWORD\* pErrorCode)

**DESCRIPTION**

VCS\_StartRecorder starts data recording. Not available with Linux.

**PARAMETERS**

KeyHandle	HANDLE	Handle for port access
NodeId	WORD	Node-ID of the addressed device

**RETURN PARAMETERS**

pErrorCode	DWORD*	Error information on the executed function
------------	--------	--

<b>Return Value</b>	BOOL	Nonzero if successful; otherwise "0"
---------------------	------	--------------------------------------

### 6.2.2 VCS\_StopRecorder

**FUNCTION**

BOOL VCS\_StopRecorder(HANDLE KeyHandle, WORD NodeId, DWORD\* pErrorCode)

**DESCRIPTION**

VCS\_StopRecorder stops data recording. Not available with Linux.

**PARAMETERS**

KeyHandle	HANDLE	Handle for port access
NodeId	WORD	Node-ID of the addressed device

**RETURN PARAMETERS**

pErrorCode	DWORD*	Error information on the executed function
------------	--------	--

<b>Return Value</b>	BOOL	Nonzero if successful; otherwise "0"
---------------------	------	--------------------------------------

**6.2.3 VCS\_ForceTrigger****FUNCTION**

BOOL VCS\_ForceTrigger(HANDLE KeyHandle, WORD NodeId, DWORD\* pErrorCode)

**DESCRIPTION**

VCS\_ForceTrigger forces the data recording triggers. Not available with Linux.

**PARAMETERS**

KeyHandle	HANDLE	Handle for port access
NodeId	WORD	Node-ID of the addressed device

**RETURN PARAMETERS**

pErrorCode	DWORD*	Error information on the executed function
------------	--------	--

<b>Return Value</b>	BOOL	Nonzero if successful; otherwise "0"
---------------------	------	--------------------------------------

**6.2.4 VCS\_IsRecorderRunning****FUNCTION**

BOOL VCS\_IsRecorderRunning(HANDLE KeyHandle, WORD NodeId, BOOL\* pRunning, DWORD\* pErrorCode)

**DESCRIPTION**

VCS\_IsRecorderRunning returns the data recorder status "running". Not available with Linux.

**PARAMETERS**

KeyHandle	HANDLE	Handle for port access
NodeId	WORD	Node-ID of the addressed device

**RETURN PARAMETERS**

pRunning	BOOL	1: Data recorder running 0: Data recorder stopped
pErrorCode	DWORD*	Error information on the executed function

<b>Return Value</b>	BOOL	Nonzero if successful; otherwise "0"
---------------------	------	--------------------------------------

## 6.2.5 VCS\_IsRecorderTriggered

### FUNCTION

BOOL VCS\_IsRecorderTriggered(HANDLE KeyHandle, WORD NodeId, BOOL\* pTriggered, DWORD\* pErrorCode)

### DESCRIPTION

VCS\_IsRecorderTriggered returns data recorder status "triggered". Not available with Linux.

### PARAMETERS

KeyHandle	HANDLE	Handle for port access
NodeId	WORD	Node-ID of the addressed device

### RETURN PARAMETERS

pTriggered	BOOL*	1: Data recorder triggered 0: Data recorder not triggered
pErrorCode	DWORD*	Error information on the executed function

<b>Return Value</b>	BOOL	Nonzero if successful; otherwise "0"
---------------------	------	--------------------------------------



## 6.3 Data Recorder Data

### 6.3.1 VCS\_ReadChannelVectorSize

#### FUNCTION

BOOL VCS\_ReadChannelVectorSize(HANDLE KeyHandle, WORD NodeId, DWORD\* pVectorSize, DWORD\* pErrorCode)

#### DESCRIPTION

VCS\_ReadChannelVectorSize returns the maximal number of samples per variable. It is dynamically calculated by the data recorder. Not available with Linux.

#### PARAMETERS

KeyHandle	HANDLE	Handle for port access
NodeId	WORD	Node-ID of the addressed device

#### RETURN PARAMETERS

pVectorSize	DWORD*	Maximal number of samples per variable
pErrorCode	DWORD*	Error information on the executed function

<b>Return Value</b>	BOOL	Nonzero if successful; otherwise "0"
---------------------	------	--------------------------------------

### 6.3.2 VCS\_ReadVCS\_ChannelDataVector

#### FUNCTION

BOOL VCS\_ReadChannelDataVector(HANDLE KeyHandle, WORD NodeId, BYTE ChannelNumber, BYTE\* pDataVector, DWORD VectorSize, DWORD\* pErrorCode)

#### DESCRIPTION

VCS\_ReadChannelDataVector returns the data points of a selected channel. Not available with Linux.

#### PARAMETERS

KeyHandle	HANDLE	Handle for port access
NodeId	WORD	Node-ID of the addressed device
ChannelNumber	BYTE	Selected channel
VectorSize	DWORD	Size of data points

#### RETURN PARAMETERS

pDataVector	BYTE*	Data points of selected channel
pErrorCode	DWORD*	Error information on the executed function

<b>Return Value</b>	BOOL	Nonzero if successful; otherwise "0"
---------------------	------	--------------------------------------

### 6.3.3 VCS\_ShowChannelDataDlg

**FUNCTION**

BOOL VCS\_ShowChannelDataDlg(HANDLE KeyHandle, WORD NodeId, DWORD\* pErrorCode)

**DESCRIPTION**

VCS\_ShowChannelDataDlg opens the dialog to show the data channel(s). Not available with Linux.

**PARAMETERS**

KeyHandle	HANDLE	Handle for port access
NodeId	WORD	Node-ID of the addressed device

**RETURN PARAMETERS**

pErrorCode	DWORD*	Error information on the executed function
------------	--------	--

<b>Return Value</b>	BOOL	Nonzero if successful; otherwise "0"
---------------------	------	--------------------------------------

### 6.3.4 VCS\_ExportChannelDataToFile

**FUNCTION**

BOOL VCS\_ExportChannelDataToFile(HANDLE KeyHandle, WORD NodeId, char\* FileName, DWORD\* pErrorCode)

**DESCRIPTION**

VCS\_ExportChannelDataToFile saves the data point in a file. Not available with Linux.

**PARAMETERS**

KeyHandle	HANDLE	Handle for port access
NodeId	WORD	Node-ID of the addressed device
FileName	char*	Path and file name to save data points (*.csv, *.txt, *.rda)

**RETURN PARAMETERS**

pErrorCode	DWORD*	Error information on the executed function
------------	--------	--

<b>Return Value</b>	BOOL	Nonzero if successful; otherwise "0"
---------------------	------	--------------------------------------

## 6.4 Advanced Functions

### 6.4.1 VCS\_ReadDataBuffer

#### FUNCTION

BOOL VCS\_ReadDataBuffer(HANDLE KeyHandle, WORD NodeId, BYTE\* pDataBuffer, DWORD BufferSizeToRead, DWORD\* pBufferSizeRead, WORD\* pVectorStartOffset, WORD\* pMaxNbOfSamples, WORD\* pNbOfRecordedSamples, DWORD\* pErrorCode)

#### DESCRIPTION

VCS\_ReadDataBuffer returns the buffer data points.

#### PARAMETERS

KeyHandle	HANDLE	Handle for port access
NodeId	WORD	Node-ID of the addressed device
BufferSizeToRead	DWORD	Buffer size

#### RETURN PARAMETERS

pDataBuffer	BYTE*	Data points
pBufferSizeRead	DWORD*	Size of read data buffer
pVectorStartOffset	WORD*	Offset to the start of the recorded data vector within the ring buffer
pMaxNbOfSamples	WORD*	Maximal number of samples per variable
pNbOfRecordedSamples	WORD*	Number of recorded samples
pErrorCode	DWORD*	Error information on the executed function

<b>Return Value</b>	BOOL	Nonzero if successful; otherwise "0"
---------------------	------	--------------------------------------

## 6.4.2 VCS\_ExtractChannelDataVector

### FUNCTION

BOOL VCS\_ExtractChannelDataVector(HANDLE KeyHandle, WORD NodeId, BYTE ChannelNumber, BYTE\* pDataBuffer, DWORD BufferSize, BYTE\* pDataVector, DWORD VectorSize, WORD VectorStartOffset, WORD MaxNbOfSamples, WORD NbOfRecordedSamples, DWORD\* pErrorCode)

### DESCRIPTION

VCS\_ExtractChannelDataVector returns the vector of a data channel.

### PARAMETERS

KeyHandle	HANDLE	Handle for port access
NodeId	WORD	Node-ID of the addressed device
ChannelNumber	BYTE	Selected channel
pDataBuffer	BYTE*	Data points
BufferSize	DWORD	Buffer size
VectorSize	DWORD	Vector size
VectorStartOffset	WORD	Offset to the start of the recorded data vector within the ring buffer
MaxNbOfSamples	WORD	Maximal number of samples per variable
NbOfRecordedSamples	WORD	Number of recorded samples

### RETURN PARAMETERS

pDataVector	BYTE*	Data points of the channel
pErrorCode	DWORD*	Error information on the executed function

<b>Return Value</b>	BOOL	Nonzero if successful; otherwise "0"
---------------------	------	--------------------------------------

## 7 Low Layer Functions



### Availability of functions

The availability of certain functions depends on the used hardware. For an overview → “Appendix A — Hardware vs. Functions” on page 11-161.

### 7.1 CAN Layer

#### 7.1.1 VCS\_SendCANFrame

##### FUNCTION

BOOL VCS\_SendCANFrame(HANDLE KeyHandle, WORD CobID, WORD Length, void\* pData, DWORD\* pErrorCode)

##### DESCRIPTION

VCS\_SendCANFrame sends a general CAN frame to the CAN bus.

##### PARAMETERS

KeyHandle	HANDLE	Handle for port access
CobID	WORD	CAN frame 11-bit identifier
Length	WORD	CAN frame data length
pData	void*	CAN frame data

##### RETURN PARAMETERS

pErrorCode	DWORD*	Error information on the executed function
------------	--------	--

<b>Return Value</b>	BOOL	Nonzero if successful; otherwise “0”
---------------------	------	--------------------------------------

#### 7.1.2 VCS\_ReadCANFrame

##### FUNCTION

BOOL VCS\_ReadCANFrame(HANDLE KeyHandle, WORD CobID, WORD Length, void\* pData, DWORD Timeout, DWORD\* p ErrorCode)

##### DESCRIPTION

VCS\_ReadCANFrame reads a general CAN frame from the CAN bus.

##### PARAMETERS

KeyHandle	HANDLE	Handle for port access
CobID	WORD	CAN frame 11-bit identifier
Length	WORD	CAN frame data length
Timeout	WORD	Maximum waiting period

##### RETURN PARAMETERS

pData	void*	CAN frame data
pErrorCode	DWORD*	Error information on the executed function

<b>Return Value</b>	BOOL	Nonzero if successful; otherwise “0”
---------------------	------	--------------------------------------

### 7.1.3 VCS\_RequestCANFrame

**FUNCTION**

BOOL VCS\_RequestCANFrame(HANDLE KeyHandle, WORD CobID, WORD Length, void\* pData, DWORD\* pErrorCode)

**DESCRIPTION**

VCS\_RequestCANFrame requests a general CAN frame from the CAN bus using Remote Transmit Request (RTR).

**PARAMETERS**

KeyHandle	HANDLE	Handle for port access
CobID	WORD	CAN frame 11-bit identifier
Length	WORD	CAN frame data length

**RETURN PARAMETERS**

pData	void*	CAN frame data
pErrorCode	DWORD*	Error information on the executed function

<b>Return Value</b>	BOOL	Nonzero if successful; otherwise "0"
---------------------	------	--------------------------------------

### 7.1.4 VCS\_SendNMTService

**FUNCTION**

BOOL VCS\_SendNMTService(HANDLE KeyHandle, WORD NodeId, WORD CommandSpecifier, DWORD\* pErrorCode)

**DESCRIPTION**

VCS\_SendNMTService is used to send a NMT protocol from a master to one slave/all slaves in a network. Command is without acknowledge.

**PARAMETERS**

KeyHandle	HANDLE	Handle for port access
NodeId	WORD	1...127: NMT slave with given Node-ID 0: All NMT slaves
CommandSpecifier	WORD	NMT service (→Table 7-31)

**RETURN PARAMETERS**

pErrorCode	DWORD*	Error information on the executed function
------------	--------	--

<b>Return Value</b>	BOOL	Nonzero if successful; otherwise "0"
---------------------	------	--------------------------------------

Description	Value	Name
Start remote node	1	NCS_START_REMOTE_NODE
Stop remote node	2	NCS_STOP_REMOTE_NODE
Enter pre-operational	128	NCS_ENTER_PRE_OPERATIONAL
Reset node	129	NCS_RESET_NODE
Reset communication	130	NCS_RESET_COMMUNICATION

Table 7-31 Command specifier

## 8 Error Overview

### 8.1 Communication Errors

Abort Code	Name	Error Cause
0x0000 0000	No error	Communication was successful
0x0503 0000	Toggle error	Toggle bit not alternated
0x0504 0000	SDO timeout	SDO protocol timed out
0x0504 0001	Client/server specifier error	Client/server command specifier not valid or unknown
0x0504 0002	Invalid block size	Invalid block size (block mode only)
0x0504 0003	Invalid sequence	Invalid sequence number (block mode only)
0x0504 0004	CRC error	CRC error (block mode only)
0x0504 0005	Out of memory error	Out of memory
0x0601 0000	Access error	Unsupported access to an object (e.g. write command to a read-only object)
0x0601 0001	Write only	Read command to a write only object
0x0601 0002	Read only	Write command to a read only object
0x0602 0000	Object does not exist	Last read or write command had a wrong object index or subindex
0x0604 0041	PDO mapping error	Object cannot be mapped to PDO
0x0604 0042	PDO length error	Number and length of objects to be mapped would exceed PDO length
0x0604 0043	General parameter error	General parameter incompatibility
0x0604 0047	General internal Incompatibility error	General internal incompatibility in device
0x0606 0000	Hardware error	Access failed due to a hardware error
0x0607 0010	Service parameter error	Data type does not match, length or service parameter does not match
0x0607 0012	Service parameter too high	Data type does not match, length or service parameter too high
0x0607 0013	Service Parameter too low	Data type does not match, length or service parameter too low
0x0609 0011	Object subindex error	Last read or write command had a wrong subindex
0x0609 0030	Value range error	Value range of parameter exceeded
0x0609 0031	Value too high	Value of parameter written too high
0x0609 0032	Value too low	Value of parameter written too low
0x0609 0036	Maximum less minimum error	Maximum value is less than minimum value
0x0800 0000	General error	General error
0x0800 0020	Transfer or store error	Data cannot be transferred or stored
0x0800 0021	Local control error	Data cannot be transferred or stored to application because of local control
0x0800 0022	Wrong device state	Data cannot be transferred or stored to application because of present device state
0x0F00 FFB9	CAN ID error	Wrong CAN ID
0x0F00 FFBC	Service mode error	Device is not in service mode
0x0F00 FFBE	Password error	Password is wrong
0x0F00 FFBF	Illegal command	RS232 command is illegal (does not exist)
0x0F00 FFC0	Wrong NMT state	Device is in wrong NMT state

Table 8-32 Communication errors

## 8.2 Library Errors

### 8.2.1 General Errors

Abort Code	Name	Error Cause
0x0000 0000	No error	Communication was successful
0x1000 0001	Internal error	Internal error
0x1000 0002	Null pointer	Null pointer passed to function
0x1000 0003	Handle not valid	Handle passed to function is not valid
0x1000 0004	Bad virtual device name	Virtual device name is not valid
0x1000 0005	Bad device name	Device name is not valid
0x1000 0006	Bad protocol stack name	Protocol stack name is not valid
0x1000 0007	Bad interface name	Interface name is not valid
0x1000 0008	Bad port name	Port is not valid
0x1000 0009	Library not loaded	Could not load external library
0x1000 000A	Command failed	Error while executing command
0x1000 000B	Timeout	Timeout occurred during execution
0x1000 000C	Bad parameter	Bad parameter passed to function
0x1000 000D	Command aborted by user	Command was aborted by user
0x1000 000E	Buffer too small	Buffer is too small
0x1000 000F	No communication found	No communication settings found
0x1000 0010	Function not supported	Function is not supported
0x1000 0011	Parameter already used	Parameter is already in use
0x1000 0013	Bad device handle	Bad device handle
0x1000 0014	Bad protocol stack handle	Bad protocol stack handle
0x1000 0015	Bad interface handle	Bad interface handle
0x1000 0016	Bad port handle	Bad port handle
0x1000 0017	Address parameters are not correct	Address parameters are not correct
0x1000 0020	Bad device state	Bad device state
0x1000 0021	Bad file content	Bad file content
0x1000 0022	Path does not exist	System cannot find specified path
0x1000 0024	Cross thread error	(.NET only) Open device and close device called from different threads
0x1000 0026	Gateway support error	Gateway is not supported
0x1000 0027	Serial number update error	Serial number update failed
0x1000 0028	Communication interface error	Communication interface is not supported
0x1000 0029	Firmware support error	Firmware version does not support functionality
0x1000 002A	Firmware file hardware error	Firmware file does not match hardware version
0x1000 002B	Firmware file error	Firmware file does not match or is corrupt

Table 8-33 General errors



**8.2.2 Interface Layer Errors**

Abort Code	Name	Error Cause
0x2000 0001	Opening interface error	Error while opening interface
0x2000 0002	Closing Interface error	Error while closing interface
0x2000 0003	Interface is not open	Interface is not open
0x2000 0004	Opening port error	Error while opening port
0x2000 0005	Closing port error	Error while closing port
0x2000 0006	Port is not open	Port is not open
0x2000 0007	Resetting port error	Error while resetting port
0x2000 0008	Configuring port settings error	Error while configuring port settings
0x2000 0009	Configuring port mode error	Error while configuring port mode

Table 8-34 Interface layer errors

**8.2.2.1 Interface Layer "RS232" Errors**

Abort Code	Name	Error Cause
0x2100 0001	RS232 write data error	Error while writing RS232 data
0x2100 0002	RS232 read data error	Error while reading RS232 data

Table 8-35 Interface layer "RS232" errors

**8.2.2.2 Interface Layer "CAN" Errors**

Abort Code	Name	Error Cause
0x2200 0001	CAN receive frame error	Error while receiving CAN frame
0x2200 0002	CAN transmit frame error	Error while transmitting CAN frame

Table 8-36 Interface layer "CAN" errors

**8.2.2.3 Interface Layer "USB" Errors**

Abort Code	Name	Error Cause
0x2300 0001	USB write data error	Error while writing data
0x2300 0002	USB read data error	Error while reading data

Table 8-37 Interface layer "USB" errors

**8.2.2.4 Interface Layer "HID" Errors**

Abort Code	Name	Error Cause
0x2400 0001	HID write data error	Error while writing USB data to HID device
0x2400 0002	HID read data error	Error while reading USB data from HID device

Table 8-38 Interface layer "HID" errors

## 8.2.3 Protocol Layer Errors

### 8.2.3.1 Protocol Layer “MAXON\_RS232” Errors

Abort Code	Name	Error Cause
0x3100 0001	Negative acknowledge received	Negative acknowledge received
0x3100 0002	Bad CRC received	Bad checksum received
0x3100 0003	Bad data received	Bad data size received

Table 8-39 Protocol layer “MAXON\_RS232” errors

### 8.2.3.2 Protocol Layer “CANopen” Errors

Abort Code	Name	Error Cause
0x3200 0001	SDO response not received	CAN frame of SDO protocol not received
0x3200 0002	Requested CAN frame not received	Requested CAN frame not received
0x3200 0003	CAN frame not received	CAN frame not received

Table 8-40 Protocol layer “CANopen” errors

### 8.2.3.3 Protocol Layer “Maxon Serial V2” Errors

Abort Code	Name	Error Cause
0x3400 0001	Stuffing error	Failure while stuffing data
0x3400 0002	Destuffing error	Failure while destuffing data
0x3400 0003	Bad CRC received	Bad CRC received
0x3400 0004	Bad data size received	Bad data size received
0x3400 0005	Bad data size written	Bad data size written
0x3400 0006	Serial data frame not written	Failure occurred while writing data
0x3400 0007	Serial data frame not received	Failure occurred while reading data

Table 8-41 Protocol layer “Maxon Serial V2” errors

### 8.2.3.4 Device Layer Errors

Abort Code	Name	Error Cause
0x5100 0001	Bad data size received	Object data size does not correspond to requested data size
0x5100 0007	Sensor configuration not supported	Sensor configuration cannot be written to controller
0x5100 0008	Sensor configuration unknown	Sensor configuration read from controller is not supported by library
0x5100 0009	Configuration not supported	Configuration is not supported
0x5100 000A	Digital input mask not supported	Digital input mask is not supported

Table 8-42 Device layer errors

## **9 Supported Operating Systems**

Consider this chapter as a “How To” on the integration of the library into your programming environment.

The «EPOS Command Library» is an implementation of protocols to communicate between an EPOS Positioning Controller and a PC running a Windows or Linux 32-bit or 64-bit operating system. All EPOS commands (including generating/sending/receiving data frames) are implemented and they can be called directly from your own program.

Use the library as an easy and simple way to develop your own application. Do not bother about protocol details; the only thing you need to ensure are the correct communication port settings.

The chapter splits into descriptions for Windows (→as of page 9-140) and Linux (→as of page 9-152) operating systems and comprises the following sections:

- a) Overview
- b) Integration and programming environment-specific information on how to incorporate the library
- c) Programming and a programming environment-specific example on how to configure and establish communication

## 9.1 Windows

### 9.1.1 Overview

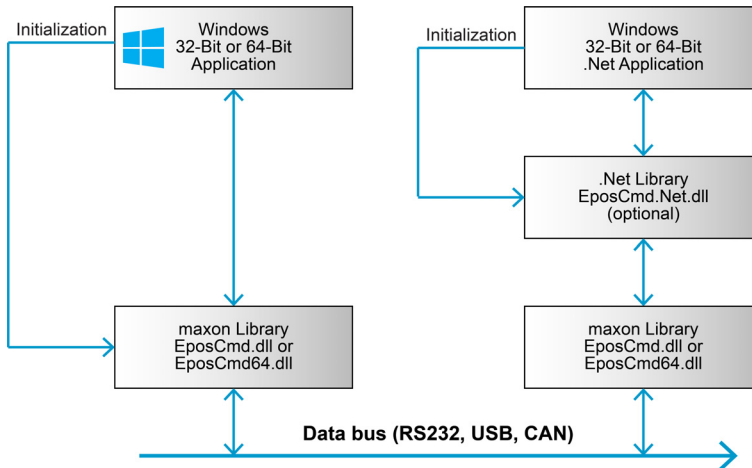

Figure 9-23 Windows – Library hierarchy

The Windows library supports communication interfaces and system architectures as shown in the following table:

Interface		Architecture	
		x86	x64
RS232		X	X
USB		X	X
CAN	IXXAT	X	X
	Kvaser	X	X
	NI	X	X
	Vector	X	X

Table 9-43 Supported platforms, architectures, and interfaces



#### **CANopen Hardware**

Use one of the listed CANopen interface cards (for details →page 2-10), for which respective motion control libraries are available. All other CANopen products may also be used, however, maxon motor does not provide respective libraries.

### 9.1.2 Integration into Programming Environment

The way to include the library functions in your own windows program depends on the compiler and the programming language you are using. Subsequently described are the procedures based on the most commonly used programming languages.

To include the library and to establish communication, proceed as follows:

- 1) Copy the library **EposCmd.dll** (for Windows 32-bit) or **EposCmd64.dll** for Windows 64-bit) to your working directory.
- 2) Use the function **VCS\_OpenDevice** to configure the library if the settings are known. You also may use the dialog **VCS\_OpenDeviceDlg** to open a port.
- 3) Use the function **VCS\_SetProtocolStackSettings** to select baud rate and timeout.
- 4) Close all opened ports at the end of your program.
- 5) For detailed information on the initialization procedure → chapter “9.1.3 Programming” on page 9-149.

#### 9.1.2.1 Borland C++ Builder

You will need to integrate the following files:

- **Definitions.h** – Constant definitions and declarations of library functions
- **EposCmd.dll** – Dynamic link library
- **EposCmd.lib** – Import library (OMF format)

Proceed as follows:

- 1) Copy the files to the working directory of your project.
- 2) Include the file “Definition.h” to your program code using the instruction “#include Definitions.h”.
- 3) Add the file “EposCmd.lib” to the project using menu **Project\Add to project**. Select the file and click **Open**.

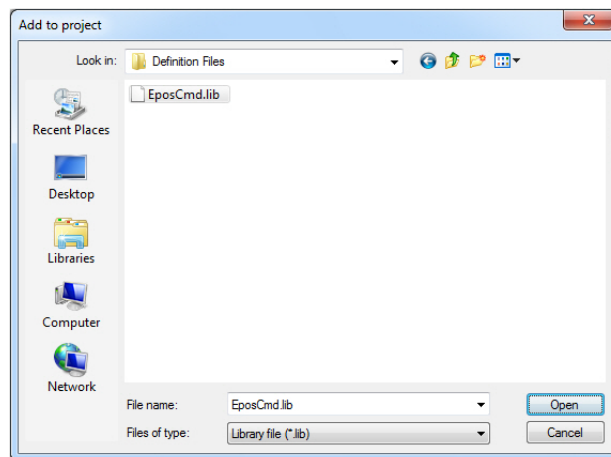

Figure 9-24 Borland C++Builder – Adding library

- 4) Now, you can execute all library functions in your own code.



#### Best Practice

Use the calling convention `__stdcall`. It will manage how the parameters are put on the stack and how the stack will be cleaned once executed.

## 9.1.2.2 Borland Delphi

You will need to integrate the following files:

- **Definitions.pas** – Constant definitions and declarations of library functions
- **EposCmd.dll** – Dynamic link library

Proceed as follows:

- 1) Copy the files to the working directory of your project.
- 2) Write the instruction “Definitions” into the uses clause of your program header.
- 3) Now, you can execute all library functions in your own code.

## 9.1.2.3 Microsoft Visual Basic



### Remark

The «EPOS Command Library» was developed in programming language Microsoft Visual C++. Take note that data types in Microsoft Visual Basic and Microsoft Visual C++ differ. For more details consult the MSDN library, *Visual Basic Concepts*, →«*Converting C Declarations to Visual Basic*».

---

You will need to integrate the following files:

### 32-bit

- **Definitions.vb** – Constant definitions and declarations of library functions
- **EposCmd.dll** – Dynamic link library

### 64-bit

- **Definitions.vb** – Constant definitions and declarations of library functions
- **EposCmd64.dll** – Dynamic link library

Proceed as follows:

- 1) Copy the files to the working directory of your project.
- 2) Add the file “Definitions.vb” to the project using the project tree in “Solution Explorer”. Click right on **Add**, select **Existing Item**, select the file, and click **Add**.

Continued on next page.

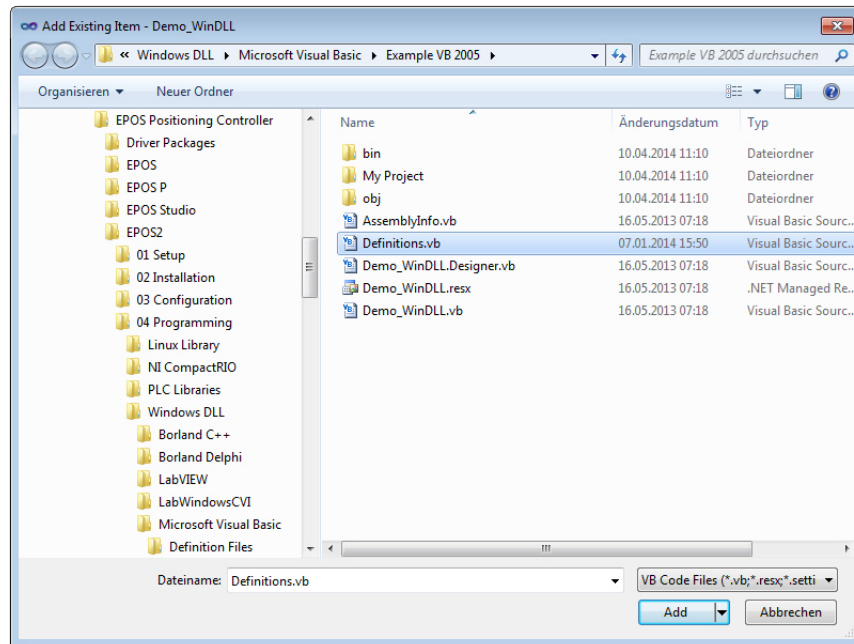

Figure 9-25 Visual Basic – Adding modules

- 3) Choose one of the two ways:
  - a) Copy the file “EposCmd.dll” (for Windows 32-bit) or “EposCmd64.dll” for Windows 64-bit) into the release directory.
  - b) Open menu “Properties”, switch to the “Compile” tab and type “.\” into the “Build output path” edit line.

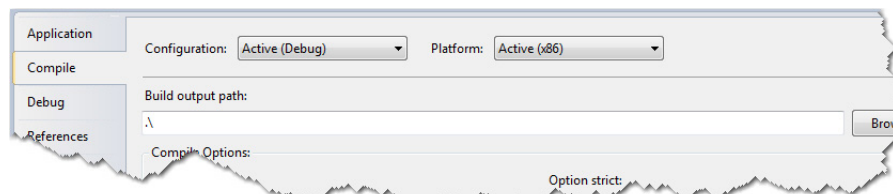

Figure 9-26 Visual Basic – Output path

- 4) Now, you can execute all library functions in your own code.

### 9.1.2.4 Microsoft Visual Basic .NET

You will need to integrate the following files:

- **EposCmd.Net.dll** – .Net assembly
- **EposCmd.dll/ EposCmd64.dll** – Dynamic link library

Proceed as follows:

- 1) Copy the files to the working directory of your project.
- 2) Add the .NET assembly "EposPCmd.Net.dll" to the project references using the project tree in "Solution Explorer". Click right on **Add**, select **Existing Item**, select the file, and click **Add**.

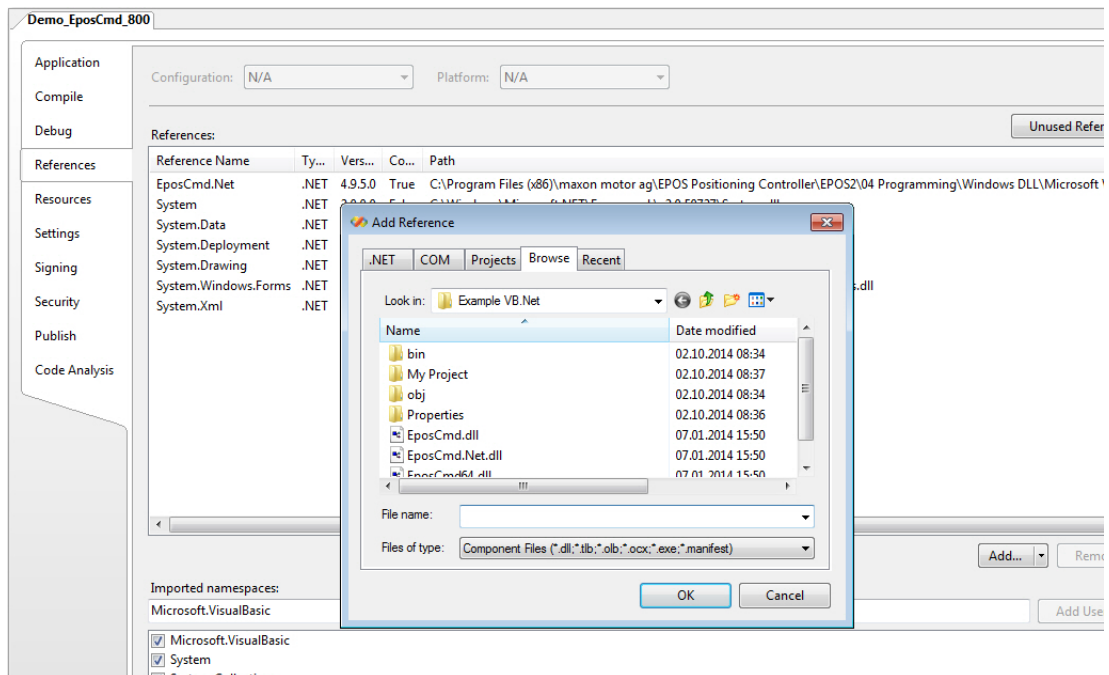

Figure 9-27 Visual Basic .NET – Adding modules

- 3) Choose one of the two ways:
  - a) Copy the file "EposCmd.dll" (for Windows 32-bit) or "EposCmd64.dll" (for Windows 64-bit) into the release directory.
  - b) Open menu **Properties**, switch to the **Compile** tab and type `.\` into the **Build output path** edit line.

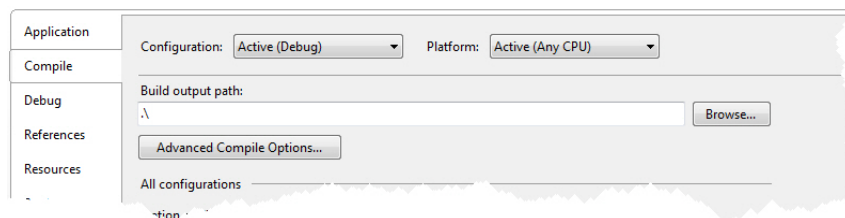

Figure 9-28 Visual Basic .NET – Output path

Continued on next page.



- 4) Now, you can execute all library functions in your own code.

**Remark**

For further details and parameter description of the EposCmd.Net wrapper → separate document «EposCmd.Net.chm».

**9.1.2.5 Microsoft Visual C#**

You will need to integrate the following files:

- **EposCmd.Net.dll** – .Net assembly
- **EposCmd.dll/ EposCmd64.dll** – Dynamic link library

Proceed as follows:

- 1) Copy the files to the working directory of your project.
- 2) Setup the using directory in your program code using the instruction “using EposCmd.Net;”.
- 3) Add the file “EposCmd.Net” to the project using the project tree in “Solution Explorer”. Click right on **References**, select **Add Reference**, select the file, and click **OK**.

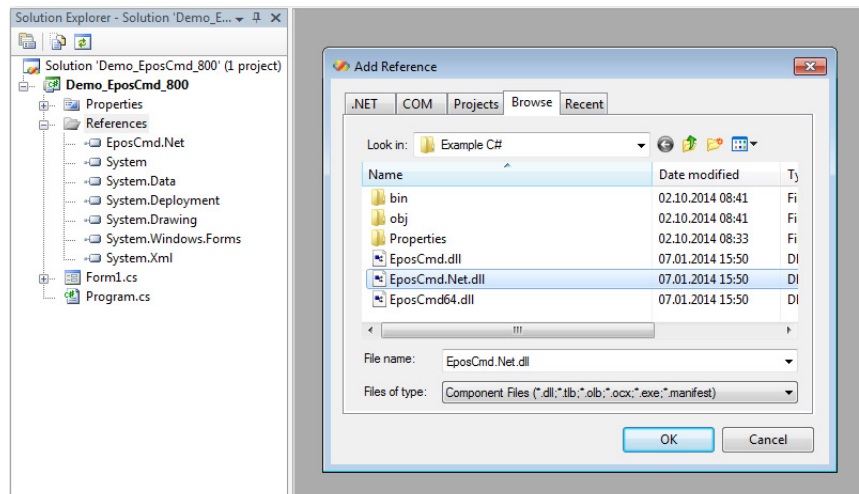

Figure 9-29 Visual C# – Project settings

- 4) Now, you can execute all library functions in your own code.

**Remark**

For further details and parameter description of the EposCmd.Net wrapper → separate document «EposCmd.Net.chm».

## 9.1.2.6 Microsoft Visual C++

You will need to integrate the following files:

### 32-bit

- **Definitions.h** – Constant definitions and declarations of library functions
- **EposCmd.dll** – Dynamic link library
- **EposCmd.lib** – Import library (COFF format)

### 64-bit

- **Definitions.h** – Constant definitions and declarations of library functions
- **EposCmd64.dll** – Dynamic link library
- **EposCmd64.lib** – Import library (COFF format)

Proceed as follows:

- 1) Copy the files to the working directory of your project.
- 2) Include the file “Definition.h” to your program code using the instruction “#include Definitions.h”.
- 3) Add the library to your project using menu “Project\Properties”. Select “Linker\Input” from the tree and type the file name “EposCmd.lib” (for Windows 32-bit) or “EposCmd64.lib” (for Windows 64-bit) into the “Additional Dependencies” edit line.

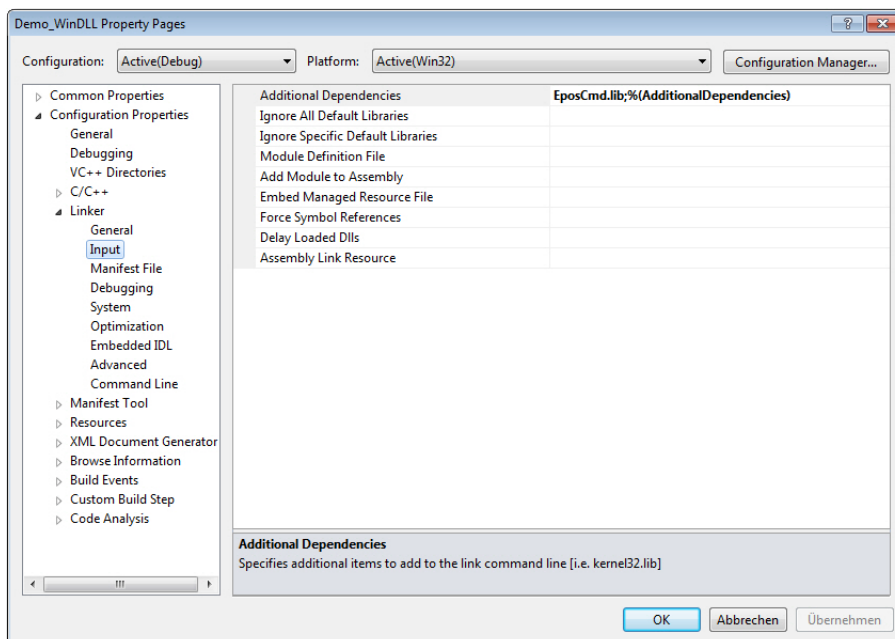

Figure 9-30 Visual C++ – Project settings

- 4) Now, you can execute all library functions in your own code.



### Best Practice

Use the calling convention `__stdcall`. It will manage how the parameters are put on the stack and how the stack will be cleaned once executed.

## 9.1.2.7 National Instruments LabVIEW

For an easy start with LabVIEW programming, most of the function blocks are already configured in a LabVIEW project structure.

VIs are supported with LabVIEW 2010 and higher.

Proceed as follows:

Either start the LabVIEW project “maxon EPOS.lvproj” or add the complete folder “maxon EPOS” to your project.

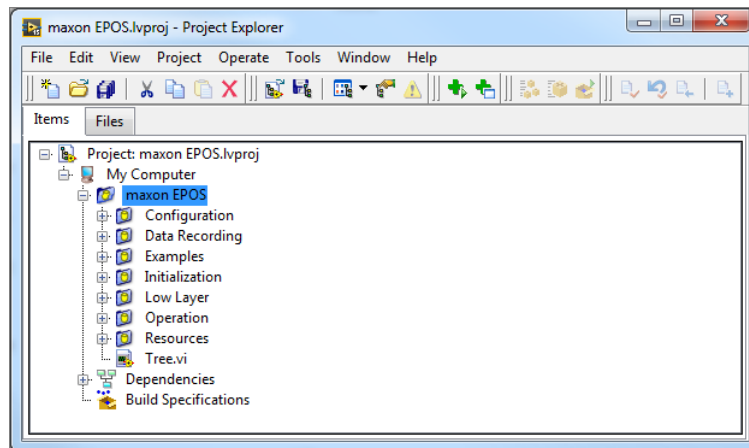

Figure 9-31 LabVIEW – Project Structure

## 9.1.2.8 National Instruments LabWindows

You will need to integrate the following files:

### 32-bit

- **Definitions.h** – Constant definitions and declarations of library functions
- **EposCmd.dll** – Dynamic link library
- **EposCmd.lib** – Import library

### 64-bit

- **Definitions.h** – Constant definitions and declarations of library functions
- **EposCmd64.dll** – Dynamic link library
- **EposCmd64.lib** – Import library



### Import Library (\*.lib)

The import library is dependent on compiler:

- For Borland compiler use the file from the directory "...borland".
- For Microsoft Visual C++ compiler use the file from the directory "...msvc".

Proceed as follows:

- 1) Copy the files to the working directory of your project.
- 2) Include the file "Definition.h" to your program code using the instruction "#include Definitions.h".
- 3) Add the files...
  - "Definitions.h", "EposCmd.dll", "EposCmd.lib" (for Windows 32-bit) or
  - "Definitions.h", "EposCmd64.dll", "EposCmd64.lib" (for Windows 64-bit)
 ... to your project using menu "Edit\Add to project".  
 Click "All Files...", select the files, and click "Add".

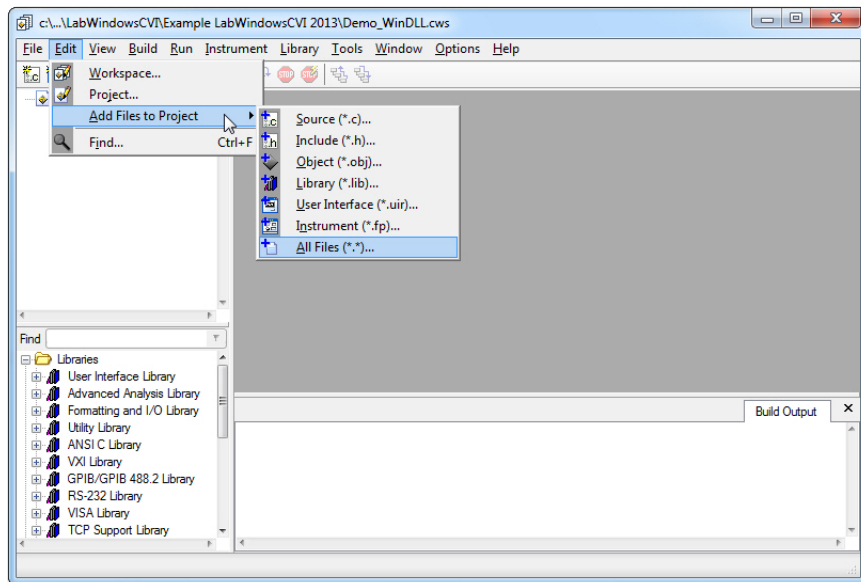

Figure 9-32 LabWindows – add files to project

- 4) Now, you can execute all library functions in your own code.



### Best Practice

Use the calling convention `__stdcall`. It will manage how the parameters are put on the stack and how the stack will be cleaned once executed.

## 9.1.3 Programming

For correct communication with the EPOS, you must execute an initialization function before the first communication command. The fundamental program flow is as follows:

### INITIALIZATION

Execute the functions at the beginning of the program.

Function	Description
VCS_OpenDevice	Initialization of the port with the user data. Use the help functions for information on the interface settings.
VCS_OpenDeviceDlg	Initialization of the port. The dialog shows all available communication ports.
VCS_SetProtocolStackSettings	Initialization of the new baud rate and timeout
VCS_ClearFault	Deletes possibly existent errors/warnings

### HELP

Use the functions if you do not exactly know how your interface is configured.

Function	Description
VCS_GetDeviceNameSelection	Returns available DeviceNames for function VCS_OpenDevice
VCS_GetProtocolStackNameSelection	Returns available ProtocolStackNames for function VCS_OpenDevice
VCS_GetInterfaceNameSelection	Returns available InterfaceNames for function VCS_OpenDevice
VCS_GetPortNameSelection	Returns available PortNames for function VCS_OpenDevice

### COMMUNICATION WITH EPOS

Choose any of the EPOS commands.

Function	Description
VCS_OperationMode	Set the operation mode (Position Mode, Profile Position Mode, Current Mode, ...)
VCS_GetEncoderParameter	Read all encoder parameters
etc.	

### CLOSING PROCEDURE

Release the port before closing the program.

Function	Description
VCS_CloseDevice	Release the opened port
VCS_CloseAllDevices	Release all opened ports

## 9.1.3.1 Examples



### Applicability

- For an universally valid example applicable for most programming environments → **Demo\_WinDLL**.
- For a National Instruments LabView-specific example → **LabVIEW**.



### Best Practice

Prior starting one of the example programs, set the control parameters (e.g. motor, sensor, and regulator parameters). Use the «EPOS Studio» for configuration.

### DEMO\_WINDLL

The example “Demo\_WinDLL” is a dialog-based application. It demonstrates how to configure communication with the EPOS device.

- 1) A configuration dialog will open as you adjust your communication settings.
- 2) At the beginning, the EPOS is set into “Profile Position Mode”. Initialization is programmed in the member function **Create()** of the class **Demo\_WinDLL**. The opened port is released at the end in the function **Destroy()**.
- 3) You can execute the EPOS commands by clicking the buttons.
  - VCS\_SetEnableState
  - VCS\_SetDisableState
  - VCS\_MoveToPosition
  - VCS\_HaltPositionMovement

The function **VCS\_MoveToPosition** may be used as absolute or relative positioning. Click «Device Settings» to change your communication settings.

A timer triggers a periodical update of the state and actual position. The function **UpdateStatus()** will be executed every 100 ms. If an error occurs during the update of the state, the timer is stopped and an error report is displayed.

## LABVIEW

The maxon EPOS instrument driver contains the following example VIs:

### MOVEWITHVELOCITY

Example to perform a velocity movement showing how to...

- initialize and close an interface (e.g. USB)
- start a velocity movement with correct operation mode
- wait until the target velocity is reached (e.g. 5 seconds)

### MOVETORELATIVEPOSITION

Example to do a relative position step showing how to...

- initialize and close an interface (e.g. USB)
- start positioning with correct operation mode
- wait until the target position is reached

### DATARECORDER

Example to configure and use the data recording functions showing how to...

- initialize and close an interface (e.g. USB)
- configure the data recorder
- start relative positioning
- display the recorded data (position, velocity, current)

### GUI DEMO

Example on how to work with maxon EPOS VIs showing how to...

- initialize and close an interface (with a dialog)
- configure parameters and data
- enable/disable a device
- start/stop a relative movement
- configure profile and node settings
- use the data recorder
- update actual values

### MOVEWITHIPM

Example on how to do an IPM trajectory showing how to...

- initialize and close an interface (e.g. USB)
- configure interpolated position mode parameters
- start IPM trajectory
- add PVT reference points
- stop IPM trajectory

## 9.2 Linux

### 9.2.1 Overview

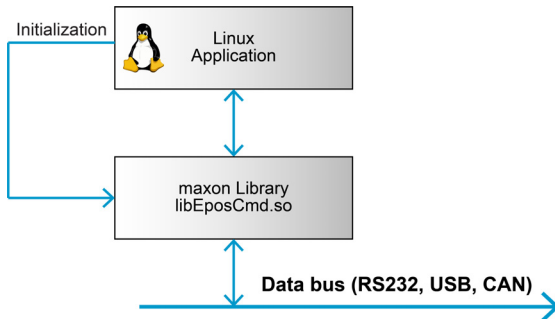

Figure 9-33 Linux – Library hierarchy

The Linux library supports communication interfaces and system architectures as shown in the following table:

Interface	Architecture					
	Intel		ARM			
	32-bit X86	64-bit X86_64	32-bit		64-bit	
			V6	V7/V8	V8	
RS232	X	X	—	X	—	
USB	X	X	X	X	X	
CAN	IXXAT	X	X	—	X	—
	Kvaser	X	X	—	X	—
	PiCAN2	—	—	—	X	—
	MTTCAN	—	—	—	—	X

Table 9-44 Supported platforms, architectures, and interfaces



#### Tested setups

- *x86 / x86\_64: Tested on Ubuntu 12.04, 14.04 and 16.04 32/64-bit*
- *ARMv6 32-bit: Tested on Raspberry Pi Zero, Raspbian Stretch*
- *ARMv7/v8: Tested on Raspberry Pi 2/3, Raspbian Stretch 32-bit*
- *ARMv7/v8 - IXXAT: Requires modification of the official IXXAT installation script (install USB only)*
- *ARMv8 64-bit: Tested on NVIDIA Jetson TX2, Ubuntu 16.04, R28, revision 2.1*



**9.2.1.1 Tested CAN Interfaces and Drivers**

Communication via CAN interfaces works through the SocketCAN driver and networking stack. Depending on the CAN interface model and brand you might need to install special drivers or upgrade the Linux kernel of your system.

The following CAN adapters and driver versions were successfully tested:

**IXXAT (IXXAT SocketCAN Driver 1.1.138)**

- IXXAT USB-to-CAN V2 Professional
- IXXAT USB-to-CAN V2 Compact

**Kvaser (SocketCAN kernel driver)**

- Kvaser Leaf Light v1
- Kvaser Leaf Light v2 (supported by Ubuntu 14.04 and newer)

**SK Pang (SocketCAN kernel driver)**

- PiCAN2 (based on MCP2511 CAN transceiver)
- Nvidia Jetson TX2 (MTTCAN SocketCAN driver), built-in CAN Interface with additional CAN transceiver

**Other CAN adapters**

Other CAN adapters might work with the library as well (SocketCAN interface driver required), but have not been tested.

## 9.2.2 Installation / Uninstallation

### 9.2.2.1 Unzipping the EPOS\_Linux\_Library

Unzip the EPOS\_Linux\_Library package:

```
$unzip EPOS_Linux_Library.zip -d .
```

**NOTE:** If the unzip program is not available, you can install it using the following command:

```
$sudo apt-get install unzip
```

### 9.2.2.2 Installing the EPOS Command Library

Go to the directory “EPOS\_Linux\_Library”:

```
$cd EPOS_Linux_Library
```

The install.sh script installs the EPOS Command Library and associated files to the directory “/opt/EposCmdLib\_<version>” and configures device access rights on the system:

```
$sudo bash ./install.sh
```

**NOTE:** install.sh script requires sudo (root privileges)

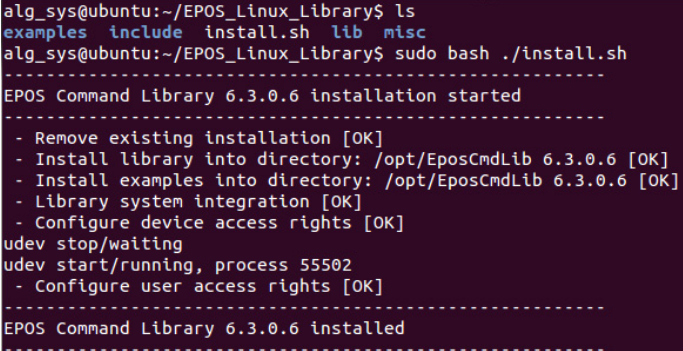

```
alg_sys@ubuntu:~/EPOS_Linux_Library$ ls
examples include install.sh lib misc
alg_sys@ubuntu:~/EPOS_Linux_Library$ sudo bash ./install.sh
-----
EPOS Command Library 6.3.0.6 installation started
-----
- Remove existing installation [OK]
- Install library into directory: /opt/EposCmdLib 6.3.0.6 [OK]
- Install examples into directory: /opt/EposCmdLib 6.3.0.6 [OK]
- Library system integration [OK]
- Configure device access rights [OK]
udev stop/waiting
udev start/running, process 55502
- Configure user access rights [OK]
-----
EPOS Command Library 6.3.0.6 installed
-----
```

Figure 9-34 EPOS Command Library installation

After successful installation, the EPOS Command Library is ready for use.

### 9.2.2.3 Uninstalling the EPOS Command Library

Go to the package directory:

```
$cd EPOS_Linux_Library
```

Execute the uninstall script:

```
$sudo bash ./install.sh -u
or
$sudo bash ./install.sh --uninstall
```

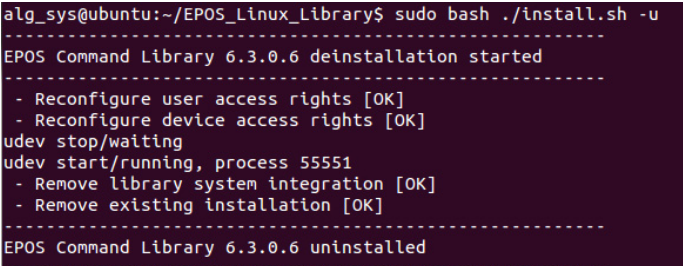

```
alg_sys@ubuntu:~/EPOS_Linux_Library$ sudo bash ./install.sh -u
-----
EPOS Command Library 6.3.0.6 deinstallation started
-----
- Reconfigure user access rights [OK]
- Reconfigure device access rights [OK]
udev stop/waiting
udev start/running, process 5551
- Remove library system integration [OK]
- Remove existing installation [OK]
-----
EPOS Command Library 6.3.0.6 uninstalled
-----
```

Figure 9-35 EPOS Command Library uninstallation

**NOTE:** The script will only uninstall the library version equal to the scripts package version.

### 9.2.3 Integration into Programming Environment

You will need to integrate the following files in your projects:

- **Definitions.h** – Constant definitions and declarations of library functions
- **libEposCmd.so.<major>.<minor>.<rev>.0** – EPOS Linux shared library

### 9.2.4 Programming

For details → Windows OS; chapter “9.1.3 Programming” on page 9-149.

The EPOS Linux library supports most of the EPOS commands. However, **not supported** are the following commands:

- DataRecorder commands
- Export/Import parameters commands
- GUI-related commands (such as VCS\_OpenDeviceDlg)

#### 9.2.4.1 Examples

##### HelloEposCmd

The demo program (source code) is available either in the package “EPOS\_Linux\_Library.zip” or after library installation in the directory “/opt/EposCmdLib\_<version>/examples/HelloEposCmd”.

##### HelloEposCmd build and execution

```
$cd /opt/EposCmdLib_<version>/examples/HelloEposCmd
$make
$./HelloEposCmd
```

**NOTE:** If the make program is not available, you can install it using the following command:

```
$sudo apt-get install build-essential
```

The main purpose of HelloEposCmd is to show the basic concept of how to use the EPOS Command Library in a custom C++ application:

- Open and close communication with the device
- Get and set communication parameters
- Selected mode demo: Profile Velocity Mode (PVM), Profile Position Mode (PPM)

The HelloEposCmd application contains useful command line parameters. Some of them can be used to identify the controller’s communication interface parameters for use with the EPOS Command Library later on.

**-h:** print out the command line parameters overview

```
alg_sys@ubuntu:~/HelloEposCmd$ ./HelloEposCmd -h
-----
Epos Command Library Example Program, (c) maxonmotor ag 2014-2017
-----
Usage: HelloEposCmd
-h : this help
-n : node id (default 1)
-d : device name (EPOS2, EPOS4, default - EPOS4)
-s : protocol stack name (MAXON_RS232, CANopen, MAXON_SERIAL_V2, default - MAXON_SERIAL_V2)
-i : interface name (RS232, USB, CAN_ixx_usb 0, CAN_kvaser_usb 0,... default - USB)
-p : port name (COM1, USB0, CAN0,... default - USB0)
-b : baudrate (115200, 1000000,... default - 1000000)
-l : list available interfaces (valid device name and protocol stack required)
-r : list supported protocols (valid device name required)
-v : display device version
alg_sys@ubuntu:~/HelloEposCmd$
```

Figure 9-36 HelloEposCmd – Parameters list

Continued on next page.

**-r:** list available protocol stacks for a selected device

```
alg_sys@ubuntu:~/HelloEposCmd$ ./HelloEposCmd -r
-----
Epos Command Library Example Program, (c) maxonmotor ag 2014-2017
-----
default settings:
node id           = 1
device name       = 'EPOS4'
protocol stack name = 'MAXON SERIAL V2'
interface name    = 'USB'
port name         = 'USB0'
baudrate          = 1000000
-----
protocol stack name = MAXON SERIAL V2
protocol stack name = CANopen
-----
```

Figure 9-37 HelloEposCmd – list available protocols

**-l:** list available interfaces and ports

```
alg_sys@ubuntu:~/HelloEposCmd$ ./HelloEposCmd -l -s 'CANopen'
-----
Epos Command Library Example Program, (c) maxonmotor ag 2014-2017
-----
default settings:
node id           = 1
device name       = 'EPOS4'
protocol stack name = 'CANopen'
interface name    = 'USB'
port name         = 'USB0'
baudrate          = 1000000
-----
interface = CAN_ixx_usb 0
          port = CAN0
          port = CAN1
-----
```

Figure 9-38 HelloEposCmd – list available interfaces

**-v:** read device version information

```
alg_sys@ubuntu:~/HelloEposCmd$ ./HelloEposCmd -s 'CANopen' -i 'CAN_ixx_usb 0' -p 'CAN0' -v
-----
Epos Command Library Example Program, (c) maxonmotor ag 2014-2017
-----
default settings:
node id           = 1
device name       = 'EPOS4'
protocol stack name = 'CANopen'
interface name    = 'CAN_ixx_usb 0'
port name         = 'CAN0'
baudrate          = 1000000
-----
Open device...
EPOS4 Hardware Version = 0x6552
      Software Version = 0x0130
      Application Number = 0xff00
      Application Version = 0x0050
Close device
-----
```

Figure 9-39 HelloEposCmd – read device version

## 10 Version History

### 10.1 Windows Operating Systems

Date [D / M / Y]	Library version	Documentation edition	Description
18.12.2018	6.5.1.0	December 2018	New: API VCS_AnalogOutputConfiguration New: API VCS_GetAnalogInputVoltage New: API VCS_GetAnalogInputState New: API VCS_SetAnalogOutputVoltage New: API VCS_SetAnalogOutputState New: API VCS_GetControllerGain, VCS_SetControllerGain New: API VCS_SendNMTService support for EPOS4 Obsolete functions (do not use): VCS_SetCurrentRegulatorGain, VCS_SetPositionRegulatorGain, VCS_SetPositionRegulatorGainFeedForward, VCS_SetVelocityRegulatorGainFeedForward, VCS_SetVelocityRegulatorGain, VCS_GetCurrentRegulatorGain, VCS_GetPositionRegulatorGain, VCS_GetPositionRegulatorGainFeedForward, VCS_GetVelocityRegulatorGainFeedForward, VCS_GetVelocityRegulatorGain
06.08.2018	6.4.2.0	August 2018	Bugfix: VCS_UpdateFirmware - EPOS4 firmware update stability fixed
08.06.2018	6.4.1.0	May 2018	New: Support firmware update EPOS4 Bugfix: VCS_SetGatewaySettings - Resetting for EPOS2 fixed Bugfix: VCS_MoveToPosition - Reset 'TargetReached' bit after start
14.12.2017	6.3.1.0	November 2017	Bugfix: Duplicate issue "Error Cluster From Code.vi" in LabView Instrument Driver resolved Bugfix: USB port enumeration conflicts between EPOS2 and EPOS4 resolved
07.06.2017	6.2.1.0	May 2017	New: API for mixed gateway topologies EPOS, EPOS2, EPOS4 New: LabView Instrument Driver Update Bugfix: .Net Library: IPM mode starting fixed
20.01.2017	6.1.2.0	January 2017	Bugfix: EPOS2 USB communication with Windows 10 and USB 3.0 Bugfix: EPOS2 Interpolated Position Mode is not starting profile
25.10.2016	6.1.1.0	October 2016	New: EPOS4 RS232 communication New: EPOS4 SSI absolute encoder
04.07.2016	6.0.1.0	May 2016	Documentation update New: Implementation of EPOS4 New: Error codes added New: Appendix A featuring matrix on hardware and supported functions
24.10.2014	5.0.1.0	October 2014	Documentation update New: Support for Kvaser CAN interfaces New: Support for NI-XNET driver
17.12.2013	4.9.5.0	December 2013	Documentation update Bugfix: Function VCS_GetDriverInfo 64-bit variant DataRecorder: Check path (VCS_ExportChannelDataToFile)
22.03.2013	4.9.2.0	March 2013	Function VCS_ExportParamter: Parameters renamed
04.01.2013	4.9.1.0	December 2012	New functions: VCS_GetHomingState, VCS_WaitForHomingAttained, VCS_GetVelocityIsAveraged, VCS_GetCurrentIsAveraged
10.10.2012	4.8.7.0	October 2012	Bugfix: Command Send NMT Service New functions: VCS_GetVelocityRegulatorFeedForward, VCS_SetVelocityRegulatorFeedForward
08.10.2012	4.8.6.0	October 2012	New: CANopen Vector Interface support for VN1600 series
10.04.2012	4.8.5.0	April 2012	Bugfix: Sporadic CAN failure with IXXAT VCI V3.3
02.02.2011	4.8.2.0	February 2011	Bugfix: NI-LIN device

Continued on next page.

Date [D / M / Y]	Library version	Documentation edition	Description
28.01.2011	4.8.1.0	January 2011	New: Expand to 64-bit Windows OS and 32-bit Linux OS Bugfix: Segmented Write
28.10.2010	4.7.3.0	November 2010	Bugfix: VCS_CloseDevice, VCS_CloseAllDevices
11.10.2010	4.7.2.0	October 2010	Bugfix: Deadlock when closing application fixed Bugfix: Communication for IXXAT VCI V3.3 fixed
30.08.2009	4.7.1.0	August 2010	New parameters: DialogMode for Findxxx functions New: ProtocolStack Name "MAXON SERIAL V2" (Library is still compatible with old name "EPOS2_USB") Bugfix: VCS_WaitForTargetReached returns false, if timeout elapses
22.10.2009	4.6.1.3	October 2009	Bugfix: Multithreading
04.09.2009	4.6.0.0	September 2009	New: Support for EPOS2 functionality, data recorder, parameter export and import, VCS_ReadCANFrame
01.05.2008	4.5.0.0	April 2008	New: Functions for read device errors (Get Device Error), adaption for EPOS2
10.08.2007	4.4.0.0	August 2007	New: Support for IXXAT VCI V3
01.02.2007	4.3.0.0	January 2007	New: Support for National Instruments Interfaces
16.10.2006	4.2.1.0	October 2006	Bugfix: VCS_GetDriverInfo, VCS_SetHomingParameter
11.10.2006	4.2.0.0	October 2006	New function: VCS_GetErrorInfo(...)
12.04.2006	4.1.1.0	April 2006	Bugfix: VCS_SendCANFrame
12.04.2006	4.1.0.0	April 2006	New error codes
03.02.2006	4.0.0.0	February 2006	Additional information on error codes
01.10.2005	4.0.0.0	October 2005	Error correction documentation
01.03.2005	3.0.0.0	March 2005	Insert from Vector CAN cards details
16.07.2004	2.0.3.0	July 2004	Documentation update New: Additional information on error codes
06.04.2004	2.0.0.0	April 2004	New functions documented: VCS_CloseAllDevices(...), VCS_DigitalInputConfiguration(...), VCS_DigitalOutputConfiguration(...), VCS_GetAllDigitalInputs(...), VCS_GetAllDigitalOutputs(...), VCS_GetAnalogInput(...), VCS_SetAllDigitalOutputs(...), VCS_SendNMService(...), VCS_OpenDeviceDlg(...) Changed functions: VCS_GetBaudrateSelection(...), VCS_FindHome(...), VCS_GetHomingParameter(...), VCS_SetHomingParameter(...), VCS_MoveToPosition(...), VCS_GetOperationMode(...), VCS_SetOperationMode(...), VCS_GetObject(...), VCS_SetObject(...) Deleted functions: VCS_GetProtocolStackMode(...), VCS_GetProtocolStackModeSelection(...)
05.01.2004	1.02	January 2004	Insert IXXAT details
01.12.2003	1.01	December 2003	Changed functions: VCS_GetBaudrateSelection(...), VCS_GetDeviceName(...), VCS_GetDeviceNameSelection(...), VCS_GetDriverInfo(...), VCS_GetInterfaceName(...), VCS_GetInterfaceNameSelection(...), VCS_GetPortName(...), VCS_GetPortNameSelection(...), VCS_GetProtocolStackModeSelection(...), VCS_GetProtocolStackName(...), VCS_GetProtocolStackNameSelection(...)
11.11.2003	1.00	November 2003	Initial release

Table 10-45 Version history – Windows OS

## 10.2 Linux Operating Systems

Date [D / M / Y]	Library version	Documentation edition	Description
18.12.2018	6.5.1.0	December 2018	New: API VCS_AnalogOutputConfiguration New: API VCS_GetAnalogInputVoltage New: API VCS_GetAnalogInputState New: API VCS_SetAnalogOutputVoltage New: API VCS_SetAnalogOutputState New: API VCS_GetControllerGain, VCS_SetControllerGain New: API VCS_SendNMTService support for EPOS4 New: ARMv8 64-bit (Nvidia Jetson TX2) New: ARMv6 32-bit (Raspberry Pi Zero) Update: FTDI driver 1.4.8 Obsolete functions (do not use): VCS_SetCurrentRegulatorGain, VCS_SetPositionRegulatorGain, VCS_SetPositionRegulatorGainFeedForward, VCS_SetVelocityRegulatorGainFeedForward, VCS_SetVelocityRegulatorGain, VCS_GetCurrentRegulatorGain, VCS_GetPositionRegulatorGain, VCS_GetPositionRegulatorGainFeedForward, VCS_GetVelocityRegulatorGainFeedForward, VCS_GetVelocityRegulatorGain
08.06.2018	6.4.1.0	May 2018	New: API for mixed gateway topologies EPOS, EPOS2, EPOS4 Improved function not supported handling
14.12.2017	6.3.1.0	November 2017	New: Support CANopen communication interfaces New: EPOS Linux Library install script Bugfix: Intel Skylake architecture lock elision issue resolved Bugfix: USB port enumeration conflicts resolved
07.06.2017	6.2.1.0	May 2017	Bugfix: Missing makefile for example added Bugfix: Wrong datatype in Definitions.h fixed
20.01.2017	6.1.1.0	January 2017	Bugfix: Make file added for example "HelloEposCmd"
25.10.2016	6.1.1.0	October 2016	New: Implementation of EPOS4
10.10.2014	5.0.1.0	October 2014	New: x86_64, arm sf/hf support New functions: VCS_GetDriverInfo Bugfix: VCS_GetErrorInfo
26.04.2013	4.9.2.0	March 2013	New functions: VCS_GetHomingState, VCS_WaitForHomingAttained, VCS_GetVelocityIsAveraged, VCS_GetCurrentIsAveraged Bugfix: rs232 baudrate
27.07.2012	4.9.1.0	December 2013	New: kernel 2.6 support Bugfix: IPM mode Update: ftdi driver
14.03.2011	4.8.2.0	February 2011	Bugfix: USB interface
15.12.2010	4.8.1.0	January 2011	Initial release

Table 10-46 Version history – Linux OS

*••page intentionally left blank••*



## Appendix A — Hardware vs. Functions

In the following tables you can find an overview on the available software functions versus their availability in the respective hardware versions. The tables are compiled in groups for initialization, configuration, operation, data recording, and low layer functions and are sorted in alphabetical order.

A click on the function's designation leads you directly to the detailed functional description.

### INITIALIZATION FUNCTIONS

Designation	EPOS	EPOS2	EPOS4
VCS_CloseAllDevices	X	X	X
VCS_CloseAllSubDevices	X	X	X
VCS_CloseDevice	X	X	X
VCS_CloseSubDevice	X	X	X
VCS_FindDeviceCommunicationSettings	X	X	X
VCS_FindSubDeviceCommunicationSettings	X	X	X
VCS_GetBaudRateSelection	X	X	X
VCS_GetDeviceName	X	X	X
VCS_GetDeviceNameSelection	X	X	X
VCS_GetDriverInfo	X	X	X
VCS_GetErrorInfo	X	X	X
VCS_GetInterfaceName	X	X	X
VCS_GetInterfaceNameSelection	X	X	X
VCS_GetKeyHandle	X	X	X
VCS_GetPortName	X	X	X
VCS_GetPortNameSelection	X	X	X
VCS_GetProtocolStackName	X	X	X
VCS_GetProtocolStackNameSelection	X	X	X
VCS_GetProtocolStackSettings	X	X	X
VCS_GetVersion	X	X	X
VCS_OpenDevice	X	X	X
VCS_OpenDeviceDlg	X	X	X
VCS_OpenSubDevice	X	X	X
VCS_OpenSubDeviceDlg	X	X	X
VCS_ResetPortNameSelection		X	X
VCS_SetProtocolStackSettings	X	X	X

Table 11-47 Hardware and their supported functions – Initialization functions

## CONFIGURATION FUNCTIONS

Designation	EPOS	EPOS2	EPOS4
VCS_AnalogInputConfiguration		X	
VCS_AnalogOutputConfiguration			X
VCS_DigitalInputConfiguration	X	X	X
VCS_DigitalOutputConfiguration	X	X	X
VCS_ExportParameter	X	X	X
VCS_GetControllerGain	X	X	X
VCS_GetDcMotorParameter	X	X	X
VCS_GetEcMotorParameter	X	X	X
VCS_GetHallSensorParameter	X	X	X
VCS_GetIncEncoderParameter	X	X	X
VCS_GetMaxAcceleration		X	X
VCS_GetMaxFollowingError	X	X	X
VCS_GetMaxProfileVelocity	X	X	X
VCS_GetMotorType	X	X	X
VCS_GetObject	X	X	X
VCS_GetSensorType	X	X	X
VCS_GetSsiAbsEncoderParameter		X	X
VCS_GetSsiAbsEncoderParameterEx			X
VCS_GetVelocityUnits		X	X
VCS_ImportParameter	X	X	X
VCS_Restore	X	X	X
VCS_SetControllerGain	X	X	X
VCS_SetDcMotorParameter	X	X	X
VCS_SetEcMotorParameter	X	X	X
VCS_SetHallSensorParameter	X	X	X
VCS_SetIncEncoderParameter	X	X	X
VCS_SetMaxAcceleration		X	X
VCS_SetMaxFollowingError	X	X	X
VCS_SetMaxProfileVelocity	X	X	X
VCS_SetMotorType	X	X	X
VCS_SetObject	X	X	X
VCS_SetSensorType	X	X	X
VCS_SetSsiAbsEncoderParameter		X	X
VCS_SetSsiAbsEncoderParameterEx			X
VCS_SetVelocityUnits		X	X
VCS_Store	X	X	X
VCS_UpdateFirmware		X	X

Table 11-48 Hardware and their supported functions – Configuration functions

**OPERATION FUNCTIONS**

Designation	EPOS	EPOS2	EPOS4
VCS_ActivateAnalogCurrentSetpoint		X	
VCS_ActivateAnalogPositionSetpoint		X	
VCS_ActivateAnalogVelocitySetpoint		X	
VCS_ActivateCurrentMode	X	X	X
VCS_ActivateHomingMode	X	X	X
VCS_ActivateInterpolatedPositionMode		X	
VCS_ActivateMasterEncoderMode	X	X	
VCS_ActivatePositionCompare		X	
VCS_ActivatePositionMarker	X	X	
VCS_ActivatePositionMode	X	X	X
VCS_ActivateProfilePositionMode	X	X	X
VCS_ActivateProfileVelocityMode	X	X	X
VCS_ActivateStepDirectionMode	X	X	
VCS_ActivateVelocityMode	X	X	X
VCS_AddPvtValueToIpmBuffer		X	
VCS_ClearFault	X	X	X
VCS_ClearIpmBuffer		X	
VCS_DeactivateAnalogCurrentSetpoint		X	
VCS_DeactivateAnalogPositionSetpoint		X	
VCS_DeactivateAnalogVelocitySetpoint		X	
VCS_DeactivatePositionCompare		X	
VCS_DeactivatePositionMarker	X	X	
VCS_DefinePosition	X	X	X
VCS_DisableAnalogCurrentSetpoint		X	
VCS_DisableAnalogPositionSetpoint		X	
VCS_DisableAnalogVelocitySetpoint		X	
VCS_DisablePositionCompare		X	
VCS_DisablePositionWindow	X	X	
VCS_DisableVelocityWindow		X	
VCS_EnableAnalogCurrentSetpoint		X	
VCS_EnableAnalogPositionSetpoint		X	
VCS_EnableAnalogVelocitySetpoint		X	
VCS_EnablePositionCompare		X	
VCS_EnablePositionWindow	X	X	
VCS_EnableVelocityWindow		X	
VCS_FindHome	X	X	X
VCS_GetAllDigitalInputs	X	X	X

Continued on next page.

Designation	EPOS	EPOS2	EPOS4
VCS_GetAllDigitalOutputs	X	X	X
VCS_GetAnalogInput	X	X	X
VCS_GetAnalogInputState		X	
VCS_GetAnalogInputVoltage	X	X	X
VCS_GetCurrentIs	X	X	X
VCS_GetCurrentIsAveraged	X	X	X
VCS_GetCurrentMust	X	X	X
VCS_GetDeviceErrorCode	X	X	X
VCS_GetDisableState	X	X	X
VCS_GetEnableState	X	X	X
VCS_GetFaultState	X	X	X
VCS_GetFreelpmBufferSize		X	
VCS_GetHomingParameter	X	X	X
VCS_GetHomingState	X	X	X
VCS_GetIpmBufferParameter		X	
VCS_GetIpmStatus		X	
VCS_GetMasterEncoderParameter		X	
VCS_GetMovementState	X	X	X
VCS_GetNbOfDeviceError	X	X	X
VCS_GetOperationMode	X	X	X
VCS_GetPositionCompareParameter		X	
VCS_GetPositionIs	X	X	X
VCS_GetPositionMarkerParameter	X	X	
VCS_GetPositionMust	X	X	X
VCS_GetPositionProfile	X	X	X
VCS_GetQuickStopState	X	X	X
VCS_GetState	X	X	X
VCS_GetStepDirectionParameter		X	
VCS_GetTargetPosition	X	X	X
VCS_GetTargetVelocity	X	X	X
VCS_GetVelocityIs	X	X	X
VCS_GetVelocityIsAveraged	X	X	X
VCS_GetVelocityMust	X	X	X
VCS_GetVelocityProfile	X	X	X
VCS_HaltPositionMovement	X	X	X
VCS_HaltVelocityMovement	X	X	X
VCS_MoveToPosition	X	X	X
VCS_MoveWithVelocity	X	X	X
VCS_ReadPositionMarkerCapturedPosition	X	X	

Continued on next page.

Designation	EPOS	EPOS2	EPOS4
VCS_ReadPositionMarkerCounter	X	X	
VCS_ResetDevice	X	X	X
VCS_ResetPositionMarkerCounter	X	X	
VCS_SetAllDigitalOutputs	X	X	X
VCS_SetAnalogOutput	X	X	X
VCS_SetAnalogOutputState			X
VCS_SetAnalogOutputVoltage		X	X
VCS_SetCurrentMust	X	X	X
VCS_SetDisableState	X	X	X
VCS_SetEnableState	X	X	X
VCS_SetHomingParameter	X	X	X
VCS_SetIpmBufferParameter		X	
VCS_SetMasterEncoderParameter		X	
VCS_SetOperationMode	X	X	X
VCS_SetPositionCompareParameter		X	
VCS_SetPositionCompareReferencePosition		X	
VCS_SetPositionMarkerParameter	X	X	
VCS_SetPositionMust	X	X	X
VCS_SetPositionProfile	X	X	X
VCS_SetQuickStopState	X	X	X
VCS_SetState	X	X	X
VCS_SetStepDirectionParameter		X	
VCS_SetVelocityMust	X	X	X
VCS_SetVelocityProfile	X	X	X
VCS_StartIpmTrajectory		X	
VCS_StopHoming	X	X	X
VCS_StopIpmTrajectory		X	
VCS_WaitForHomingAttained	X	X	X
VCS_WaitForTargetReached	X	X	X

Table 11-49 Hardware and their supported functions – Operation functions

### DATA RECORDING FUNCTIONS

Designation	EPOS	EPOS2	EPOS4
VCS_ActivateChannel	X	X	
VCS_DeactivateAllChannels	X	X	
VCS_DisableAllTriggers	X	X	
VCS_EnableTrigger	X	X	
VCS_ExportChannelDataToFile	X	X	
VCS_ExtractChannelDataVector	X	X	
VCS_ForceTrigger	X	X	
VCS_GetRecorderParameter	X	X	
VCS_IsRecorderRunning	X	X	
VCS_IsRecorderTriggered	X	X	
VCS_ReadChannelVectorSize	X	X	
VCS_ReadDataBuffer	X	X	
VCS_ReadVCS_ChannelDataVector	X	X	
VCS_SetRecorderParameter	X	X	
VCS_ShowChannelDataDlg	X	X	
VCS_StartRecorder	X	X	
VCS_StopRecorder	X	X	

Table 11-50 Hardware and their supported functions – Data recording functions

### LOW LAYER FUNCTIONS

Designation	EPOS	EPOS2	EPOS4
VCS_ReadCANFrame	X	X	
VCS_RequestCANFrame	X	X	
VCS_SendCANFrame	X	X	
VCS_SendNMTService	X	X	X

Table 11-51 Hardware and their supported functions – Low layer functions

## Appendix B — Function Groups Overview

<b>3</b>	<b>Initialization Functions</b>	<b>13</b>
3.1	Communication . . . . .	13
3.1.1	VCS_OpenDevice . . . . .	13
3.1.2	VCS_OpenDeviceDlg . . . . .	14
3.1.3	VCS_SetProtocolStackSettings . . . . .	15
3.1.4	VCS_GetProtocolStackSettings . . . . .	15
3.1.5	VCS_FindDeviceCommunicationSettings . . . . .	16
3.1.6	VCS_CloseAllDevices . . . . .	16
3.1.7	VCS_CloseDevice . . . . .	17
3.1.8	VCS_OpenSubDevice . . . . .	18
3.1.9	VCS_OpenSubDeviceDlg . . . . .	19
3.1.10	VCS_SetGatewaySettings . . . . .	19
3.1.11	VCS_GetGatewaySettings . . . . .	20
3.1.12	VCS_FindSubDeviceCommunicationSettings . . . . .	20
3.1.13	VCS_CloseAllSubDevices . . . . .	21
3.1.14	VCS_CloseSubDevice . . . . .	21
3.2	Info . . . . .	22
3.2.1	VCS_GetErrorInfo . . . . .	22
3.2.2	VCS_GetDriverInfo . . . . .	22
3.2.3	VCS_GetVersion . . . . .	23
3.3	Advanced Functions . . . . .	24
3.3.1	VCS_GetDeviceNameSelection . . . . .	24
3.3.2	VCS_GetProtocolStackNameSelection . . . . .	25
3.3.3	VCS_GetInterfaceNameSelection . . . . .	26
3.3.4	VCS_GetPortNameSelection . . . . .	27
3.3.5	VCS_ResetPortNameSelection . . . . .	28
3.3.6	VCS_GetBaudRateSelection . . . . .	29
3.3.7	VCS_GetKeyHandle . . . . .	30
3.3.8	VCS_GetDeviceName . . . . .	30
3.3.9	VCS_GetProtocolStackName . . . . .	31
3.3.10	VCS_GetInterfaceName . . . . .	31
3.3.11	VCS_GetPortName . . . . .	32

<b>4</b>	<b>Configuration Functions</b>	<b>33</b>
4.1	General . . . . .	33
4.1.1	VCS_ImportParameter . . . . .	33
4.1.2	VCS_ExportParameter . . . . .	34
4.1.3	VCS_SetObject . . . . .	35
4.1.4	VCS_GetObject . . . . .	36
4.1.5	VCS_Restore . . . . .	36
4.1.6	VCS_Store . . . . .	37
4.1.7	VCS_UpdateFirmware . . . . .	37
4.2	Advanced Functions . . . . .	38
4.2.1	Motor . . . . .	38
4.2.1.1	VCS_SetMotorType . . . . .	38
4.2.1.2	VCS_SetDcMotorParameter . . . . .	38
4.2.1.3	VCS_SetEcMotorParameter . . . . .	39
4.2.1.4	VCS_GetMotorType . . . . .	39
4.2.1.5	VCS_GetDcMotorParameter . . . . .	40
4.2.1.6	VCS_GetEcMotorParameter . . . . .	40
4.2.2	Sensor . . . . .	41
4.2.2.1	VCS_SetSensorType . . . . .	41
4.2.2.2	VCS_SetIncEncoderParameter . . . . .	42
4.2.2.3	VCS_SetHallSensorParameter . . . . .	42
4.2.2.4	VCS_SetSsiAbsEncoderParameterEx . . . . .	43
4.2.2.5	VCS_SetSsiAbsEncoderParameter . . . . .	43
4.2.2.6	VCS_GetSensorType . . . . .	44
4.2.2.7	VCS_GetIncEncoderParameter . . . . .	44
4.2.2.8	VCS_GetHallSensorParameter . . . . .	45
4.2.2.9	VCS_GetSsiAbsEncoderParameter . . . . .	45
4.2.2.10	VCS_GetSsiAbsEncoderParameterEx . . . . .	46
4.2.3	Safety . . . . .	47
4.2.3.1	VCS_SetMaxFollowingError . . . . .	47
4.2.3.2	VCS_GetMaxFollowingError . . . . .	47
4.2.3.3	VCS_SetMaxProfileVelocity . . . . .	48
4.2.3.4	VCS_GetMaxProfileVelocity . . . . .	48
4.2.3.5	VCS_SetMaxAcceleration . . . . .	49
4.2.3.6	VCS_GetMaxAcceleration . . . . .	49
4.2.4	Controller Gain . . . . .	50
4.2.4.1	VCS_SetControllerGain . . . . .	50
4.2.4.2	VCS_GetControllerGain . . . . .	50
4.2.5	Inputs/Outputs . . . . .	53
4.2.5.1	VCS_DigitalInputConfiguration . . . . .	53
4.2.5.2	VCS_DigitalOutputConfiguration . . . . .	54
4.2.5.3	VCS_AnalogInputConfiguration . . . . .	55
4.2.5.4	VCS_AnalogOutputConfiguration . . . . .	56
4.2.6	Units . . . . .	57
4.2.6.1	VCS_SetVelocityUnits . . . . .	57
4.2.6.2	VCS_GetVelocityUnits . . . . .	57



<b>5</b>	<b>Operation Functions</b>	<b>59</b>
5.1	Operation Mode . . . . .	59
5.1.1	VCS_SetOperationMode . . . . .	59
5.1.2	VCS_GetOperationMode . . . . .	60
5.2	State Machine . . . . .	61
5.2.1	VCS_ResetDevice . . . . .	61
5.2.2	VCS_SetState . . . . .	61
5.2.3	VCS_SetEnableState . . . . .	62
5.2.4	VCS_SetDisableState . . . . .	62
5.2.5	VCS_SetQuickStopState . . . . .	62
5.2.6	VCS_ClearFault . . . . .	63
5.2.7	VCS_GetState . . . . .	63
5.2.8	VCS_GetEnableState . . . . .	64
5.2.9	VCS_GetDisableState . . . . .	64
5.2.10	VCS_GetQuickStopState . . . . .	65
5.2.11	VCS_GetFaultState . . . . .	65
5.3	Error Handling . . . . .	66
5.3.1	VCS_GetNbOfDeviceError . . . . .	66
5.3.2	VCS_GetDeviceErrorCode . . . . .	67
5.4	Motion Info . . . . .	68
5.4.1	VCS_GetMovementState . . . . .	68
5.4.2	VCS_GetPositionIs . . . . .	68
5.4.3	VCS_GetVelocityIs . . . . .	69
5.4.4	VCS_GetVelocityIsAveraged . . . . .	69
5.4.5	VCS_GetCurrentIs . . . . .	70
5.4.6	VCS_GetCurrentIsAveraged . . . . .	70
5.4.7	VCS_WaitForTargetReached . . . . .	71
5.5	Profile Position Mode (PPM) . . . . .	72
5.5.1	VCS_ActivateProfilePositionMode . . . . .	72
5.5.2	VCS_SetPositionProfile . . . . .	72
5.5.3	VCS_GetPositionProfile . . . . .	73
5.5.4	VCS_MoveToPosition . . . . .	73
5.5.5	VCS_GetTargetPosition . . . . .	74
5.5.6	VCS_HaltPositionMovement . . . . .	74
5.5.7	Advanced Functions . . . . .	75
5.5.7.1	VCS_EnablePositionWindow . . . . .	75
5.5.7.2	VCS_DisablePositionWindow . . . . .	75
5.6	Profile Velocity Mode (PVM) . . . . .	76
5.6.1	VCS_ActivateProfileVelocityMode . . . . .	76
5.6.2	VCS_SetVelocityProfile . . . . .	76
5.6.3	VCS_GetVelocityProfile . . . . .	77
5.6.4	VCS_MoveWithVelocity . . . . .	77
5.6.5	VCS_GetTargetVelocity . . . . .	78
5.6.6	VCS_HaltVelocityMovement . . . . .	78
5.6.7	Advanced Functions . . . . .	79
5.6.7.1	VCS_EnableVelocityWindow . . . . .	79
5.6.7.2	VCS_DisableVelocityWindow . . . . .	79

5.7	Homing Mode (HM) . . . . .	80
5.7.1	VCS_ActivateHomingMode . . . . .	80
5.7.2	VCS_SetHomingParameter . . . . .	80
5.7.3	VCS_GetHomingParameter . . . . .	81
5.7.4	VCS_FindHome . . . . .	82
5.7.5	VCS_StopHoming . . . . .	83
5.7.6	VCS_DefinePosition . . . . .	83
5.7.7	VCS_GetHomingState . . . . .	84
5.7.8	VCS_WaitForHomingAttained . . . . .	84
5.8	Interpolated Position Mode (IPM) . . . . .	85
5.8.1	VCS_ActivateInterpolatedPositionMode . . . . .	85
5.8.2	VCS_SetIpmBufferParameter . . . . .	85
5.8.3	VCS_GetIpmBufferParameter . . . . .	86
5.8.4	VCS_ClearIpmBuffer . . . . .	86
5.8.5	VCS_GetFreeIpmBufferSize . . . . .	87
5.8.6	VCS_AddPvtValueToIpmBuffer . . . . .	87
5.8.7	VCS_StartIpmTrajectory . . . . .	88
5.8.8	VCS_StopIpmTrajectory . . . . .	88
5.8.9	VCS_GetIpmStatus . . . . .	89
5.9	Position Mode (PM) . . . . .	90
5.9.1	VCS_ActivatePositionMode . . . . .	90
5.9.2	VCS_SetPositionMust . . . . .	90
5.9.3	VCS_GetPositionMust . . . . .	91
5.9.4	Advanced Functions . . . . .	91
5.9.4.1	VCS_ActivateAnalogPositionSetpoint . . . . .	91
5.9.4.2	VCS_DeactivateAnalogPositionSetpoint . . . . .	92
5.9.4.3	VCS_EnableAnalogPositionSetpoint . . . . .	92
5.9.4.4	VCS_DisableAnalogPositionSetpoint . . . . .	93
5.10	Velocity Mode (VM) . . . . .	94
5.10.1	VCS_ActivateVelocityMode . . . . .	94
5.10.2	VCS_SetVelocityMust . . . . .	94
5.10.3	VCS_GetVelocityMust . . . . .	95
5.10.4	Advanced Functions . . . . .	95
5.10.4.1	VCS_ActivateAnalogVelocitySetpoint . . . . .	95
5.10.4.2	VCS_DeactivateAnalogVelocitySetpoint . . . . .	96
5.10.4.3	VCS_EnableAnalogVelocitySetpoint . . . . .	96
5.10.4.4	VCS_DisableAnalogVelocitySetpoint . . . . .	97
5.11	Current Mode (CM) . . . . .	98
5.11.1	VCS_ActivateCurrentMode . . . . .	98
5.11.2	VCS_GetCurrentMust . . . . .	98
5.11.3	VCS_SetCurrentMust . . . . .	99
5.11.4	Advanced Functions . . . . .	99
5.11.4.1	VCS_ActivateAnalogCurrentSetpoint . . . . .	99
5.11.4.2	VCS_DeactivateAnalogCurrentSetpoint . . . . .	100
5.11.4.3	VCS_EnableAnalogCurrentSetpoint . . . . .	100
5.11.4.4	VCS_DisableAnalogCurrentSetpoint . . . . .	101
5.12	Master Encoder Mode (MEM) . . . . .	102
5.12.1	VCS_ActivateMasterEncoderMode . . . . .	102
5.12.2	VCS_SetMasterEncoderParameter . . . . .	102
5.12.3	VCS_GetMasterEncoderParameter . . . . .	103

5.13	Step Direction Mode (SDM) . . . . .	104
5.13.1	VCS_ActivateStepDirectionMode . . . . .	104
5.13.2	VCS_SetStepDirectionParameter . . . . .	104
5.13.3	VCS_GetStepDirectionParameter . . . . .	105
5.14	Inputs & Outputs . . . . .	106
5.14.1	VCS_GetAllDigitalInputs . . . . .	106
5.14.2	VCS_GetAllDigitalOutputs . . . . .	107
5.14.3	VCS_SetAllDigitalOutputs . . . . .	108
5.14.4	VCS_GetAnalogInput . . . . .	109
5.14.5	VCS_GetAnalogInputVoltage . . . . .	109
5.14.6	VCS_GetAnalogInputState . . . . .	110
5.14.7	VCS_SetAnalogOutput . . . . .	111
5.14.8	VCS_SetAnalogOutputVoltage . . . . .	111
5.14.9	VCS_SetAnalogOutputState . . . . .	112
5.14.10	Position Compare . . . . .	113
5.14.10.1	VCS_SetPositionCompareParameter . . . . .	113
5.14.10.2	VCS_GetPositionCompareParameter . . . . .	114
5.14.10.3	VCS_ActivatePositionCompare . . . . .	115
5.14.10.4	VCS_DeactivatePositionCompare . . . . .	115
5.14.10.5	VCS_EnablePositionCompare . . . . .	116
5.14.10.6	VCS_DisablePositionCompare . . . . .	116
5.14.10.7	VCS_SetPositionCompareReferencePosition . . . . .	117
5.14.11	Position Marker . . . . .	118
5.14.11.1	VCS_SetPositionMarkerParameter . . . . .	118
5.14.11.2	VCS_GetPositionMarkerParameter . . . . .	119
5.14.11.3	VCS_ActivatePositionMarker . . . . .	119
5.14.11.4	VCS_DeactivatePositionMarker . . . . .	120
5.14.11.5	VCS_ReadPositionMarkerCounter . . . . .	120
5.14.11.6	VCS_ReadPositionMarkerCapturedPosition . . . . .	121
5.14.11.7	VCS_ResetPositionMarkerCounter . . . . .	121

<b>6</b>	<b>Data Recording Functions</b>	<b>123</b>
6.1	Operation Mode . . . . .	123
6.1.1	VCS_SetRecorderParameter.....	123
6.1.2	VCS_GetRecorderParameter.....	123
6.1.3	VCS_EnableTrigger.....	124
6.1.4	VCS_DisableAllTriggers.....	124
6.1.5	VCS_ActivateChannel.....	125
6.1.6	VCS_DeactivateAllChannels.....	125
6.2	Data Recorder Status. . . . .	126
6.2.1	VCS_StartRecorder.....	126
6.2.2	VCS_StopRecorder.....	126
6.2.3	VCS_ForceTrigger.....	127
6.2.4	VCS_IsRecorderRunning.....	127
6.2.5	VCS_IsRecorderTriggered.....	128
6.3	Data Recorder Data . . . . .	129
6.3.1	VCS_ReadChannelVectorSize.....	129
6.3.2	VCS_ReadVCS_ChannelDataVector.....	129
6.3.3	VCS_ShowChannelDataDlg.....	130
6.3.4	VCS_ExportChannelDataToFile.....	130
6.4	Advanced Functions. . . . .	131
6.4.1	VCS_ReadDataBuffer.....	131
6.4.2	VCS_ExtractChannelDataVector.....	132
<b>7</b>	<b>Low Layer Functions</b>	<b>133</b>
7.1	CAN Layer . . . . .	133
7.1.1	VCS_SendCANFrame.....	133
7.1.2	VCS_ReadCANFrame.....	133
7.1.3	VCS_RequestCANFrame.....	134
7.1.4	VCS_SendNMTService.....	134

**LIST OF FIGURES**

Figure 2-1 EPOS2 documentation structure ..... 9

Figure 2-2 EPOS4 documentation structure ..... 9

Figure 2-3 Windows / Linux – Communication structure (example). .... 11

Figure 2-4 Gateway – Communication structure (example). .... 11

Figure 3-5 VCS\_OpenDevice (programming example) ..... 14

Figure 3-6 VCS\_OpenDevice (example) ..... 14

Figure 3-7 VCS\_SetProtocolStackSettings (programming example). .... 15

Figure 3-8 VCS\_OpenSubDevice (programming example). .... 18

Figure 3-9 VCS\_OpenSubDevice (example) ..... 18

Figure 3-10 VCS\_GetDeviceNameSelection (programming example) ..... 24

Figure 3-11 VCS\_GetProtocolStackNameSelection (programming example). .... 25

Figure 3-12 VCS\_GetInterfaceNameSelection (programming example). .... 26

Figure 3-13 VCS\_GetPortNameSelection (programming example) ..... 27

Figure 3-14 VCS\_GetBaudrateSelection (programming example) ..... 29

Figure 4-15 VCS\_ImportParameter (programming example) ..... 33

Figure 4-16 VCS\_ExportParameter (programming example) ..... 34

Figure 4-17 VCS\_UpdateFirmware (programming example). .... 37

Figure 5-18 VCS\_GetNbOfDeviceError (programming example) ..... 66

Figure 5-19 VCS\_GetDeviceErrorCode (programming example) ..... 67

Figure 5-20 VCS\_GetAllDigitalInputs (tInputs). .... 106

Figure 5-21 VCS\_GetAllDigitalOutputs (tOutputs). .... 107

Figure 5-22 VCS\_SetAllDigitalOutputs (tOutputs) ..... 108

Figure 9-23 Windows – Library hierarchy ..... 140

Figure 9-24 Borland C++Builder – Adding library ..... 141

Figure 9-25 Visual Basic – Adding modules ..... 143

Figure 9-26 Visual Basic – Output path ..... 143

Figure 9-27 Visual Basic .NET – Adding modules ..... 144

Figure 9-28 Visual Basic .NET – Output path ..... 144

Figure 9-29 Visual C# – Project settings ..... 145

Figure 9-30 Visual C++ – Project settings ..... 146

Figure 9-31 LabVIEW – Project Structure ..... 147

Figure 9-32 LabWindows – add files to project ..... 148

Figure 9-33 Linux – Library hierarchy ..... 152

Figure 9-34 EPOS Command Library installation ..... 154

Figure 9-35 EPOS Command Library uninstallation ..... 154

Figure 9-36 HelloEposCmd – Parameters list ..... 155

Figure 9-37 HelloEposCmd – list available protocols. .... 156

Figure 9-38 HelloEposCmd – list available interfaces ..... 156

Figure 9-39 HelloEposCmd – read device version. .... 156

**LIST OF TABLES**

Table 1-1 Notations used in this document . . . . . 5

Table 1-2 Sources for additional information . . . . . 6

Table 1-3 Brand Names and trademark owners . . . . . 7

Table 2-4 Third party supplier products . . . . . 10

Table 2-5 Data type definitions . . . . . 12

Table 4-6 Motor types . . . . . 38

Table 4-7 Position sensor types . . . . . 41

Table 4-8 Controller Gain – Regulation controller . . . . . 51

Table 4-9 Controller Gain – PI current controller gains . . . . . 51

Table 4-10 Controller Gain – PI velocity controller gains . . . . . 51

Table 4-11 Controller Gain – PI velocity controller gains with observer . . . . . 51

Table 4-12 Controller Gain – PID position controller gains . . . . . 52

Table 4-13 Controller Gain – Dual loop controller gains . . . . . 52

Table 4-14 Digital input configuration . . . . . 53

Table 4-15 Digital output configuration . . . . . 54

Table 4-16 Analog input configuration . . . . . 55

Table 4-17 Analog output configuration . . . . . 56

Table 4-18 Velocity notation index . . . . . 57

Table 5-19 Operation modes . . . . . 59

Table 5-20 Mapped operation modes . . . . . 60

Table 5-21 State modes . . . . . 61

Table 5-22 Homing methods . . . . . 82

Table 5-23 Analog input states . . . . . 110

Table 5-24 Analog output states . . . . . 112

Table 5-25 Position compare – Operational modes . . . . . 113

Table 5-26 Position compare – Interval modes . . . . . 113

Table 5-27 Position compare – Direction dependency . . . . . 114

Table 5-28 Position marker edge types . . . . . 118

Table 5-29 Position marker modes . . . . . 118

Table 6-30 Data recorder trigger types . . . . . 124

Table 7-31 Command specifier . . . . . 134

Table 8-32 Communication errors . . . . . 135

Table 8-33 General errors . . . . . 136

Table 8-34 Interface layer errors . . . . . 137

Table 8-35 Interface layer “RS232” errors . . . . . 137

Table 8-36 Interface layer “CAN” errors . . . . . 137

Table 8-37 Interface layer “USB” errors . . . . . 137

Table 8-38 Interface layer “HID” errors . . . . . 137

Table 8-39 Protocol layer “MAXON\_RS232” errors . . . . . 138

Table 8-40 Protocol layer “CANopen” errors . . . . . 138

Table 8-41 Protocol layer “Maxon Serial V2” errors . . . . . 138

Table 8-42 Device layer errors . . . . . 138

---

Table 9-43	Supported platforms, architectures, and interfaces . . . . .	140
Table 9-44	Supported platforms, architectures, and interfaces . . . . .	152
Table 10-45	Version history – Windows OS . . . . .	158
Table 10-46	Version history – Linux OS . . . . .	159
Table 11-47	Hardware and their supported functions – Initialization functions. . . . .	161
Table 11-48	Hardware and their supported functions – Configuration functions . . . . .	162
Table 11-49	Hardware and their supported functions – Operation functions . . . . .	165
Table 11-50	Hardware and their supported functions – Data recording functions . . . . .	166
Table 11-51	Hardware and their supported functions – Low layer functions . . . . .	166

*••page intentionally left blank••*



## INDEX

**A**

architectures (supported)  
 Linux **152**  
 Windows **140**

**B**

Borland C++ (integration into) **141**  
 Borland Delphi (integration into) **142**

**C**

CM (Current Mode) functions **98**  
 configuration functions **33**

**D**

data recording functions **123**  
 data type definitions **12**  
 Delphi (integration into) **142**  
 drivers by 3rd party manufacturers **10**

**E**

EPOS Command Library, integration of **139**  
 error codes (overview) **135**  
 Error Handling functions **66**

**F**

functions  
 configuration **33**  
 data recording **123**  
 initialization **13**  
 low layer **133**  
 operation **59**

functions for  
 Current Mode **98**  
 Homing Mode **80**  
 inputs & outputs **106**  
 Interpolated Position Mode **85**  
 Master Encoder Mode **102**  
 Position Mode **90**  
 Profile Position Mode **72**  
 Profile Velocity Mode **76**  
 Step Direction Mode **104**  
 Velocity Mode **94**

functions/hardware matrix **161, 167**

**H**

hardware/functions matrix **161, 167**  
 HM (Homing Mode) functions **80**  
 homing methods **82**  
 how to  
 integrate the «EPOS Command Library» **139**  
 interpret icons (and signs) used in the document **6**

**I**

initialization functions **13**  
 input/output functions **106**  
 interfaces (supported) **140, 152**  
 Linux **152**  
 Windows **140**  
 IPM (Interpolated Position Mode) functions **85**  
 IXXAT (supported devices) **10**

**K**

Kvaser (supported devices) **10**

**L**

LabVIEW (integration into) **147**  
 LabWindows (integration into) **148**  
 legal notice **7**  
 Linux  
 library hierarchy **152**  
 low layer functions **133**

**M**

manufacturers of supported products **10**  
 MEM (Master Encoder Mode) functions **102**  
 Motion Info functions **68**

**N**

National Instruments (supported devices) **10**  
 NI-CAN **10**  
 NI-XNET **10**

**O**

operation functions **59**  
 Operation Mode functions **59**

**P**

PM (Position Mode) functions **90**  
 PPM (Profile Position Mode) functions **72**  
 purpose of this document **5**  
 PVM (Profile Velocity Mode) functions **76**

**S**

SDM (Step Direction Mode) functions **104**  
 signs used **6**  
 State Machine functions **61**  
 supported products by 3rd party suppliers **10**  
 symbols used **6**

## V

VCI driver **10**

Vector (supported devices) **10**

Visual Basic .NET (integration into) **144**

Visual Basic (integration into) **142**

Visual C# (integration into) **145**

Visual C++ (integration into) **146**

VM (Velocity Mode) functions **94**

## W

warranty **7**

Windows

    communication structure **11**

    library hierarchies **140**

## X

XL driver **10**

*••page intentionally left blank••*

© 2018 maxon motor. All rights reserved.

The present document – including all parts thereof – is protected by copyright. Any use (including reproduction, translation, microfilming and other means of electronic data processing) beyond the narrow restrictions of the copyright law without the prior approval of maxon motor ag, is not permitted and subject to persecution under the applicable law.

**maxon motor ag**

Brünigstrasse 220  
P.O.Box 263  
CH-6072 Sachseln  
Switzerland

Phone +41 41 666 15 00  
Fax +41 41 666 16 50

[www.maxonmotor.com](http://www.maxonmotor.com)